











24

	SERVICE  → 
	(0) 91 23 95 50 
	(0) 17 18 11 43 24 
	(0) 91 23 18 51 55
	(0) 91 23 18 52 19
	Service + Spare parts
	e-mail: service@tadanofaun.de
	e-mail: spareparts@tadanofaun.de
	 → ++49

ALL-TERRAIN
ATF 80-4

ISO 9001

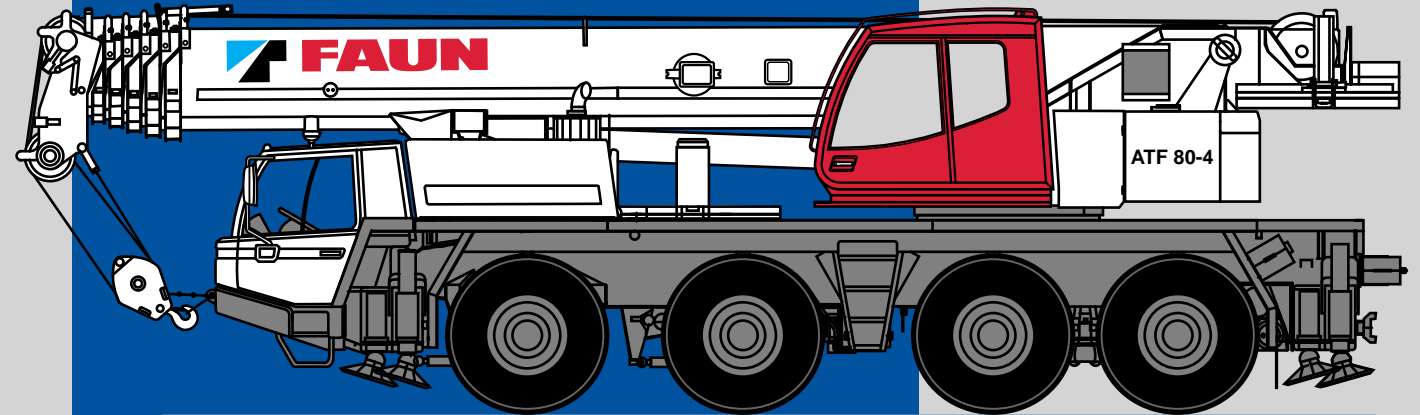

Maße (mm)
 Dimensions (mm)
 Dimensiones (mm)

 16.00 R 25

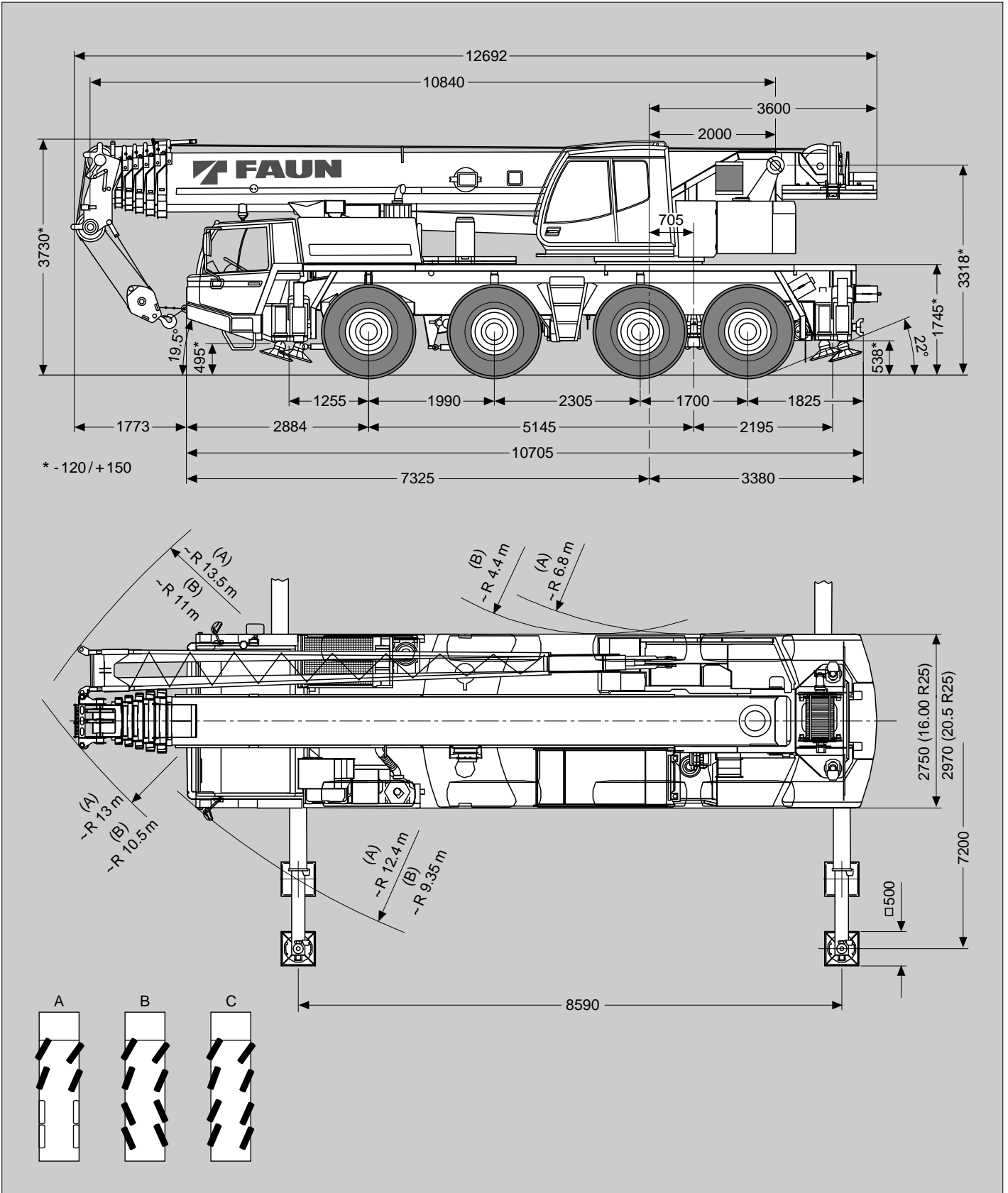

Gewichte / Geschwindigkeiten
Weights / Working speeds
Poids / Vitesses
Pesos / Velocidades de trabajo

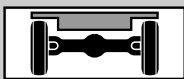
	Achse / Axle Essieu / Eje	1	2	3	4	Gesamtgewicht / Total weight Poids total / Peso total
	(t)	12	12	12	12	48*

* Incl. 6,0 t Gegengewicht, Bereifung 16.00 R 25, 9 m / 16 m Gitterspitze, 40 t Hakenflasche, 6 t Hakengeschirr, Antrieb 8 x 8.

* Incl. 6.0 t counterweight, tyres 16.00 R 25, 9 m / 16 m folding swingaway, 40 t hook block, 6 t swivel hook, drive 8 x 8.





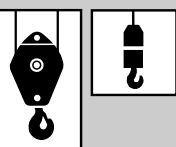

* Incl. de 6,0 t contrepoids, pneus 16.00 R 25, 9 m / 16 m extension treillis, 40 t moufle, 6 t elingues, entraînement 8 x 8.

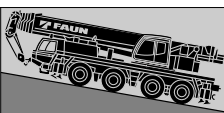
* Incl. contrapeso de 6,0 t, neumáticos 16.00 R 25, 9 m / 16 m plumín articulado, gancho de 40 t, 6 t gancho de bola, tracción 8 x 8.

	Traglast / Lifting capacity / Force de levage / Capacidad de elevación	Rollen / Sheaves Pulies / Poleas	Stränge / Parts of line Brins / Ramales de cable	Gewicht / Weight Poid / Peso
	* Doppelhaken	63 t *	5	11
* Rams horn	63 t	5	11	600 kg
* Moufle avec crochet marin	40 t *	3	7	400 kg
* Gancho doble	40 t	3	7	400 kg
	20 t	1	3	200 kg
	6 t	-	1	150 kg

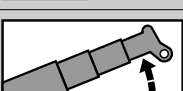

	1	2	3	4	5	6	7	8	9	10	11	12	R1	R2	
	14.00 km/h	5	6	8	11	13	17	23	29	37	48	61	78	5	
16.00 / 20.5 km/h	5	7	9	12	15	19	25	32	41	52	67	80	6	8	59%

V+ 	Stufenlos Infinitely variable Progressivement variable Infinitamente variable	Seil Rope Câble Cable	Max. Seilzug Max. single line pull Effort maxi au brin simple Trio máximo por ramal
	0 - 112 m/min für einfachen Strang single line au brin simple ramal simple	18 mm / 230 m	68 kN 1. Lage 1st layer 1er brin capa 1
	0 - 112 m/min für einfachen Strang single line au brin simple ramal simple	18 mm / 230 m	68 kN 1. Lage 1st layer 1er brin capa 1
	0 - 2 min ⁻¹		
	-2° - +80° ca. 35 s approx. 35 s env. 35 s aproximadamente 35 s		
	10.8 m - 48.5 m ca. 280 s approx. 280 s env. 280 s aproximadamente 280 s		

Tragfähigkeiten
Lifting capacities
Capacités de levage
Capacidades de elevación

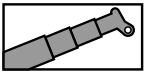

18t

DIN/ISO

 m	10.8 m	14.6 m	18.3 m	22.1 m	25.9 m	29.7 m	33.5 m	37.3 m	41.0 m	44.8 m	48.5 m
2.5	80.0*										
3.0	73.0	68.0	58.0	47.0							
3.5	66.8	63.6	58.0	45.0							
4.0	59.1	59.0	55.2	42.9	34.1						
4.5	52.6	52.5	51.0	40.9	33.2						
5.0	47.0	47.0	46.1	38.9	32.4	27.0					
6.0	38.6	38.6	37.8	34.8	30.6	25.4	21.0				
7.0	32.6	32.6	31.8	30.7	28.0	23.9	20.0	16.0	12.8		
8.0	28.0	28.0	27.2	26.6	25.4	22.3	19.1	15.4	12.8	10.0	
9.0		24.4	23.6	23.1	22.8	20.8	18.1	14.8	12.8	10.0	8.6
10.0		21.5	20.7	20.2	20.3	19.2	17.2	14.2	12.5	10.0	8.6
11.0		19.1	19.3	17.9	17.9	17.7	16.2	13.6	12.1	9.8	8.6
12.0		17.3	17.8	15.9	16.0	16.1	15.3	13.0	11.8	9.6	8.6
14.0			15.3	12.4	12.5	12.9	13.2	11.8	11.1	9.1	8.3
16.0			12.0	9.6	10.9	10.2	11.0	10.6	10.4	8.7	7.9
18.0				8.6	9.6	8.9	9.7	9.5	9.1	8.2	7.6
20.0				6.9	8.6	8.0	8.4	8.5	8.1	8.0	7.2
22.0					7.5	7.2	7.1	7.7	7.2	7.2	6.8
24.0						6.5	6.1	6.7	6.5	6.1	5.8
26.0						5.8	5.6	5.8	5.7	5.3	5.0
28.0							5.1	5.1	4.9	4.6	4.2
30.0							4.7	4.5	4.3	3.9	3.6
32.0								4.0	3.8	3.4	3.1
34.0								3.5	3.3	3.0	2.7
36.0									2.9	2.6	2.3
38.0									2.6	2.2	1.9
40.0										1.9	1.6
42.0										1.6	1.3
44.0											1.1
46.0											0.8

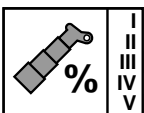

I
II
III
IV
V

0	0/0	50/0/100/0	100/0/0	100/0/0	100/0/0	100/0/0	100/100/0/0	100/0/0	100/100/0	100/50	100
0	50/0	50/0/0/0	50/0/0	100/0/0	100/0/0	100/0/0	100/100/100/0	100/100/50	100/100/100	100/100	100
0	0/0	0/0/0/0	0/0/0	0/100/0	50/100/50	50/100/50	50/100/100/100	100/100/100	100/100/100	100/100	100
0	0/0	0/50/0/0	0/100/50	0/50/100	0/50/100	0/100/100	50/0/50/100	50/100/100	50/100/100	100/100	100
0	0/50	0/50/0/100	0/50/100	0/50/100	0/50/100	0/50/100	0/0/50/100	0/50/100	50/0/100	50/100	100

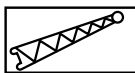
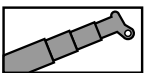

18t

DIN/ISO

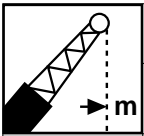
 m	44.8 m + 9.0 m			48.5 m + 9.0 m			48.5 m + 16.0 m		
	5°	20°	40°	5°	20°	40°	5°	20°	40°
10.0	6.00								
11.0	5.85			5.50					
12.0	5.70	3.85		5.50					
14.0	5.35	3.60	2.45	5.30	3.70		3.10		
16.0	5.05	3.40	2.35	5.10	3.50	2.40	2.95		
18.0	4.75	3.20	2.30	4.90	3.30	2.35	2.75	1.70	
20.0	4.40	3.05	2.20	4.65	3.15	2.25	2.60	1.60	
22.0	4.10	2.90	2.15	4.35	3.00	2.20	2.40	1.55	1.00
24.0	3.80	2.75	2.10	4.00	2.85	2.15	2.20	1.45	1.00
26.0	3.55	2.65	2.05	3.75	2.75	2.10	2.05	1.40	0.95
28.0	3.30	2.50	2.00	3.50	2.60	2.05	1.90	1.30	0.95
30.0	3.15	2.45	1.95	3.35	2.55	2.00	1.80	1.25	0.90
32.0	2.95	2.35	1.95	3.10	2.45	1.95	1.65	1.20	0.90
34.0	2.80	2.25	1.90	2.65	2.35	1.95	1.60	1.15	0.85
36.0	2.50	2.20	1.85	2.20	2.25	1.90	1.50	1.10	0.85
38.0	2.15	2.10	1.85	1.85	2.00	1.90	1.40	1.05	0.85
40.0	1.80	1.90	1.85	1.50	1.65	1.75	1.35	1.00	0.80
42.0	1.50	1.60	1.65	1.20	1.30	1.40	1.25	1.00	0.80
44.0	1.25	1.30	1.30	0.95	1.05	1.10	1.20	0.95	0.80
46.0	1.00	1.05	1.05	0.70	0.80	0.80	1.15	0.90	0.75
48.0	0.75	0.80	0.75		0.55	0.55	0.95	0.85	0.75
50.0	0.55	0.55					0.75	0.80	0.75
52.0							0.55	0.60	0.70

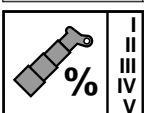

I
II
III
IV
V

100 / 50				100				100		
100 / 100				100				100		
100 / 100				100				100		
100 / 100				100				100		
50 / 100				100				100		

Hubhöhen
Lifting heights
Hauteurs de levage
Alturas de elevación

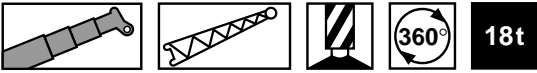

DIN/ISO

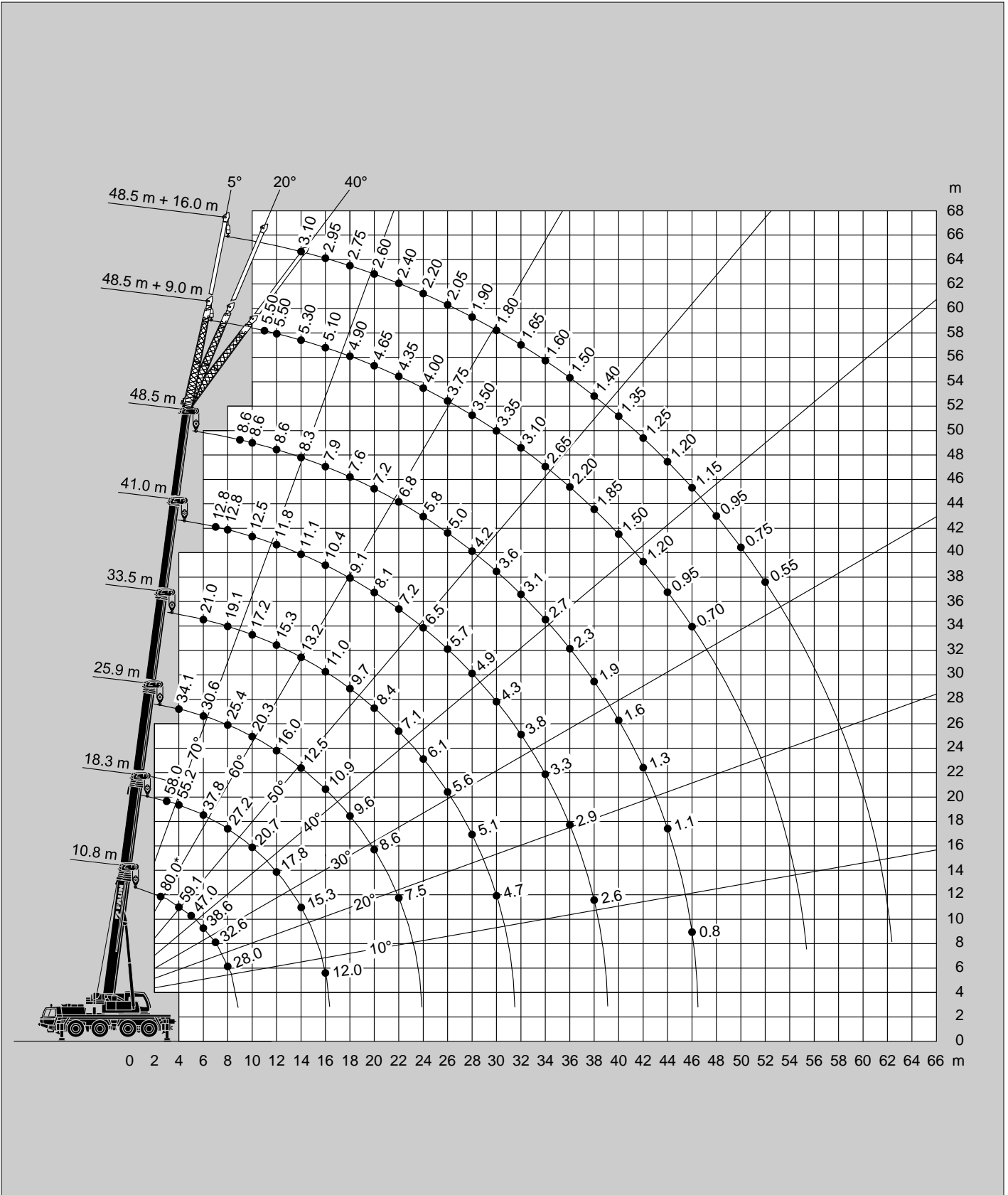

Tragfähigkeiten
Lifting capacities
Capacités de levage
Capacidades de elevación

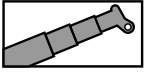

12.7t

DIN / ISO

↗ m	10.8 m	14.6 m	18.3 m	22.1 m	25.9 m	29.7 m	33.5 m	37.3 m	41.0 m	44.8 m	48.5 m	
2.5	80.0*											
3.0	73.0	68.0	58.0	47.0								
3.5	63.9	63.6	58.0	45.0								
4.0	56.1	56.0	55.0	42.9	34.1							
4.5	49.6	49.5	48.6	40.9	33.2							
5.0	44.3	44.3	43.4	38.9	32.4	27.0						
6.0	36.3	36.3	35.5	34.8	30.6	25.4	21.0					
7.0	30.6	30.6	29.8	29.2	28.0	23.9	20.0	16.0	12.8			
8.0	26.2	26.2	25.4	24.9	25.0	22.3	19.1	15.4	12.8	10.0		
9.0		22.8	22.6	21.5	21.6	20.8	18.1	14.8	12.8	10.0	8.6	
10.0		20.1	20.7	18.8	18.9	19.2	17.2	14.2	12.5	10.0	8.6	
11.0		18.5	19.1	15.9	16.1	16.5	16.2	13.6	12.1	9.8	8.6	
12.0		16.2	16.7	13.6	14.4	14.2	14.7	13.0	11.8	9.6	8.6	
14.0			13.1	10.8	12.4	11.6	12.7	11.5	11.1	9.1	8.3	
16.0			10.6	9.6	10.7	10.1	10.3	10.3	9.4	8.7	7.9	
18.0				8.6	8.8	8.9	8.4	9.1	8.6	8.2	7.6	
20.0				7.4	7.3	7.6	7.5	7.6	7.4	7.0	6.7	
22.0					6.2	6.7	6.7	6.5	6.3	5.9	5.6	
24.0						5.8	5.8	5.6	5.4	5.0	4.7	
26.0						5.1	5.0	4.8	4.6	4.2	3.9	
28.0							4.4	4.2	4.0	3.6	3.3	
30.0							3.8	3.6	3.4	3.1	2.8	
32.0								3.1	3.0	2.6	2.3	
34.0								2.7	2.6	2.2	1.9	
36.0									2.2	1.8	1.5	
38.0									1.9	1.5	1.2	
40.0										1.2	0.9	
42.0										1.0	0.7	
44.0											0.5	
%	I	0	0/0	50/0/100/0	100/0/0	100/0/0	100/0/0	100/100/0/0	100/0/0	100/100/0	100/50	100
	II	0	50/0	50/0/0/0	50/0/0	100/0/0	100/0/0	100/100/100/0	100/100/50	100/100/100	100/100	100
	III	0	0/0	0/0/0/0	0/0/0	0/100/0	50/100/50	50/100/100/100	100/100/100	100/100/100	100/100	100
	IV	0	0/0	0/50/0/0	0/100/50	0/50/100	0/100/100	50/0/50/100	50/100/100	50/100/100	100/100	100
	V	0	0/50	0/50/0/100	0/50/100	0/50/100	0/50/100	0/0/50/100	0/50/100	50/0/100	50/100	100

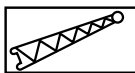
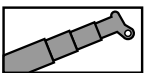

12.7t

DIN / ISO

↗ m	44.8 m + 9.0 m			48.5 m + 9.0 m			48.5 m + 16.0 m			
	5°	20°	40°	5°	20°	40°	5°	20°	40°	
10.0	6.00									
11.0	5.85			5.50						
12.0	5.70	3.85		5.50						
14.0	5.35	3.60	2.45	5.30	3.70		3.10			
16.0	5.05	3.40	2.35	5.10	3.50	2.40	2.95			
18.0	4.75	3.20	2.30	4.90	3.30	2.35	2.75	1.70		
20.0	4.40	3.05	2.20	4.65	3.15	2.25	2.60	1.60		
22.0	4.10	2.90	2.15	4.35	3.00	2.20	2.40	1.55	1.00	
24.0	3.80	2.75	2.10	4.00	2.85	2.15	2.20	1.45	1.00	
26.0	3.55	2.65	2.05	3.75	2.75	2.10	2.05	1.40	0.95	
28.0	3.30	2.50	2.00	3.30	2.60	2.05	1.90	1.30	0.95	
30.0	3.05	2.45	1.95	2.75	2.55	2.00	1.80	1.25	0.90	
32.0	2.60	2.35	1.95	2.30	2.45	1.95	1.65	1.20	0.90	
34.0	2.20	2.25	1.90	1.85	2.05	1.95	1.60	1.15	0.85	
36.0	1.80	1.90	1.85	1.50	1.65	1.75	1.50	1.10	0.85	
38.0	1.50	1.60	1.65	1.20	1.30	1.40	1.40	1.05	0.85	
40.0	1.20	1.30	1.35	0.90	1.00	1.10	1.35	1.00	0.80	
42.0	0.90	1.00	1.05	0.60	0.70	0.75	1.10	1.00	0.80	
44.0	0.70	0.75	0.75		0.50	0.50	0.90	0.95	0.80	
46.0		0.50	0.50				0.65	0.80	0.75	
48.0								0.60	0.65	
50.0										
52.0										
%	I	100 / 50			100			100		
	II	100 / 100			100			100		
	III	100 / 100			100			100		
	IV	100 / 100			100			100		
	V	50 / 100			100			100		

Hubhöhen
Lifting heights
Hauteurs de levage
Alturas de elevación

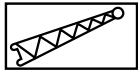
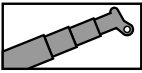

12.7t

DIN/ISO

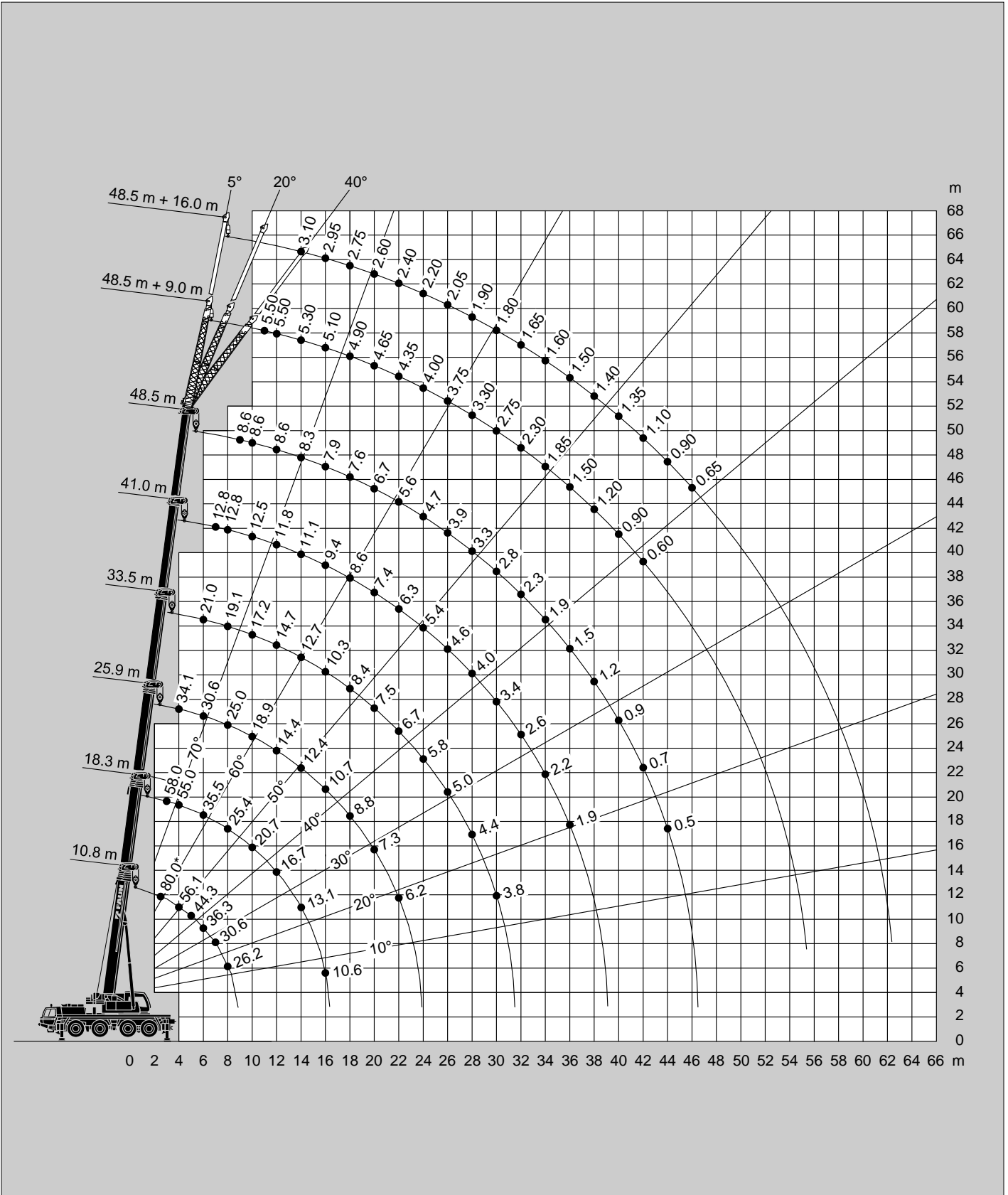

Tragfähigkeiten
Lifting capacities
Capacités de levage
Capacidades de elevación

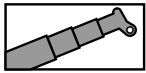

6t

DIN/ISO

↗ m	10.8 m	14.6 m	18.3 m	22.1 m	25.9 m	29.7 m	33.5 m	37.3 m	41.0 m	44.8 m	48.5 m
2.5	80.0*										
3.0	69.1	68.0	58.0	47.0							
3.5	59.4	59.4	58.0	45.0							
4.0	51.7	51.7	50.7	42.9	34.1						
4.5	45.7	45.7	44.8	40.9	33.2						
5.0	40.8	40.8	39.9	38.9	32.4	27.0					
6.0	33.4	33.4	32.6	32.0	30.6	25.4	21.0				
7.0	28.1	28.1	27.5	26.7	26.7	23.9	20.0	16.0	12.8		
8.0	23.8	23.9	24.8	22.3	22.6	22.3	19.1	15.4	12.8	10.0	
9.0		20.8	21.4	17.9	18.8	18.5	18.1	14.8	12.8	10.0	8.6
10.0		17.4	18.0	14.6	17.1	15.9	15.8	14.2	12.5	10.0	8.6
11.0		14.8	15.4	13.4	15.4	14.7	15.0	13.5	12.1	9.8	8.6
12.0		12.9	13.4	12.4	13.5	13.4	13.0	12.4	11.8	9.6	8.6
14.0			10.4	10.8	10.5	10.7	10.7	10.8	9.7	9.1	8.3
16.0			8.5	8.8	8.3	8.9	8.9	8.6	8.4	8.0	7.7
18.0				7.2	7.3	7.3	7.3	7.0	6.9	6.4	6.1
20.0				6.0	6.1	6.1	6.0	5.8	5.6	5.2	4.8
22.0					5.1	5.1	5.0	4.8	4.6	4.2	3.9
24.0						4.3	4.2	4.0	3.8	3.4	3.1
26.0						3.6	3.6	3.4	3.2	2.8	2.5
28.0							3.1	2.8	2.7	2.3	2.0
30.0							2.6	2.4	2.2	1.8	1.5
32.0								2.0	1.8	1.4	1.1
34.0								1.7	1.5	1.1	0.8
36.0									1.2	0.8	0.5
38.0									0.9	0.6	

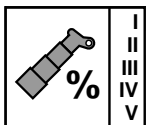

I	0	0/0	50/0/100/0	100/0/0	100/0/0	100/0/0	100/100/0/0	100/0/0	100/100/0	100/50	100
II	0	50/0	50/0/0/0	50/0/0	100/0/0	100/0/0	100/100/100/0	100/100/50	100/100/100	100/100	100
III	0	0/0	0/0/0/0	0/0/0	0/100/0	50/100/50	50/100/100/100	100/100/100	100/100/100	100/100	100
IV	0	0/0	0/50/0/0	0/100/50	0/50/100	0/100/100	50/0/50/100	50/100/100	50/100/100	100/100	100
V	0	0/50	0/50/0/100	0/50/100	0/50/100	0/50/100	0/0/50/100	0/50/100	50/0/100	50/100	100

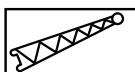
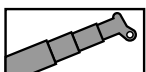

6t

DIN/ISO

↗ m	44.8 m + 9.0 m			48.5 m + 9.0 m			48.5 m + 16.0 m		
	5°	20°	40°	5°	20°	40°	5°	20°	40°
10.0	6.00								
11.0	5.85			5.50					
12.0	5.70	3.85		5.50					
14.0	5.35	3.60	2.45	5.30	3.70		3.10		
16.0	5.05	3.40	2.35	5.10	3.50	2.40	2.95		
18.0	4.75	3.20	2.30	4.90	3.30	2.35	2.75	1.70	
20.0	4.40	3.05	2.20	4.65	3.15	2.25	2.60	1.60	
22.0	4.10	2.90	2.15	4.00	3.00	2.20	2.40	1.55	1.00
24.0	3.55	2.75	2.10	3.20	2.85	2.15	2.20	1.45	1.00
26.0	2.90	2.65	2.05	2.55	2.75	2.10	2.05	1.40	0.95
28.0	2.30	2.50	2.00	2.00	2.20	2.05	1.90	1.30	0.95
30.0	1.85	2.05	1.95	1.55	1.75	1.95	1.80	1.25	0.90
32.0	1.45	1.60	1.75	1.15	1.35	1.50	1.65	1.20	0.90
34.0	1.10	1.25	1.35	0.80	0.95	1.10	1.30	1.15	0.85
36.0	0.75	0.90	1.00	0.50	0.65	0.75	0.95	1.10	0.85
38.0	0.50	0.60	0.70				0.70	0.95	0.85
40.0								0.65	0.80
42.0									0.60
44.0									
46.0									

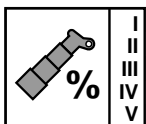

I	100 / 50			100			100		
II	100 / 100			100			100		
III	100 / 100			100			100		
IV	100 / 100			100			100		
V	50 / 100			100			100		

Hubhöhen
Lifting heights
Hauteurs de levage
Alturas de elevación

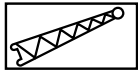
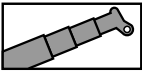

6t

DIN/ISO

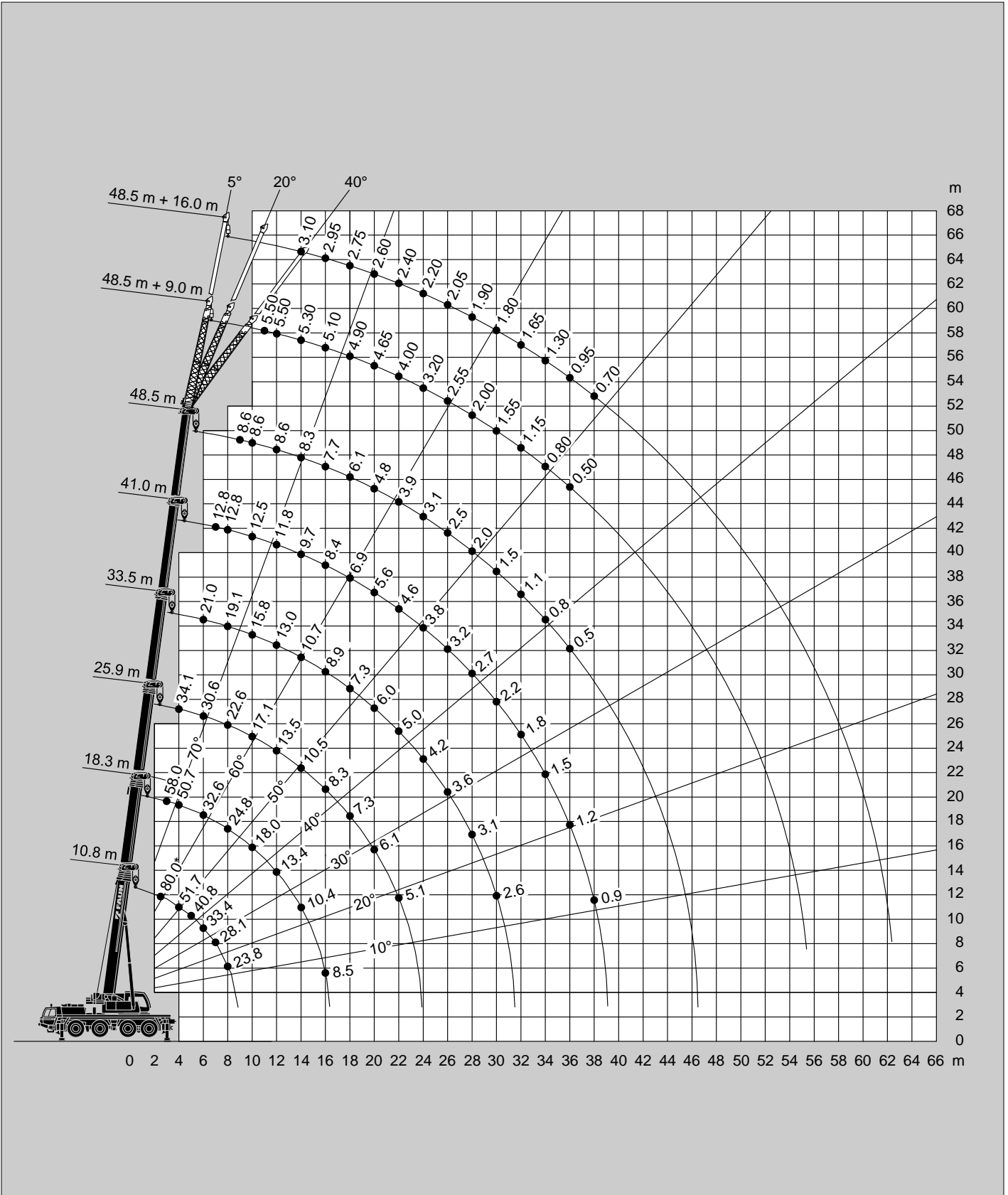

Tragfähigkeiten
Lifting capacities
Capacités de levage
Capacidades de elevación



DIN/ISO

 m	10.8 m	14.6 m	18.3 m
3.0	19.1	19.6	20.0
3.5	17.9	18.3	18.6
4.0	16.8	17.3	17.5
4.5	15.8	16.2	16.5
5.0	14.8	15.3	15.6
6.0	12.4	13.4	14.0
7.0	9.9	10.9	11.4
8.0	8.1	9.0	9.6
9.0		7.6	8.1
10.0		6.5	7.0
11.0		5.6	6.1
12.0		4.9	5.4
14.0			4.2
16.0			3.3
18.0			
20.0			
22.0			



DIN/ISO

 m	10.8 m	14.6 m	18.3 m
3.0	17.3	18.0	18.3
3.5	15.7	16.4	16.8
4.0	14.4	15.1	15.5
4.5	13.2	13.9	14.3
5.0	12.2	12.9	13.3
6.0	10.4	11.2	11.6
7.0	9.0	9.8	10.2
8.0	7.8	8.6	9.0
9.0		7.6	8.1
10.0		6.6	7.2
11.0		5.6	6.2
12.0		4.8	5.5
14.0			4.2
16.0			3.2
18.0			
20.0			
22.0			



DIN/ISO

 m	10.8 m	14.6 m	18.3 m
3.0	20.6	21.0	20.0
3.5	16.4	17.6	18.6
4.0	13.4	14.5	15.2
4.5	11.2	12.3	12.9
5.0	9.6	10.6	11.2
6.0	7.2	8.1	8.7
7.0	5.5	6.5	7.0
8.0	4.3	5.2	5.7
9.0		4.3	4.8
10.0		3.5	4.0
11.0		2.9	3.4
12.0		2.5	2.9
14.0			2.1
16.0			1.5
18.0			
20.0			
22.0			

Anmerkungen zu den Traglasttabellen

Die Tragfähigkeiten im Festigkeitsbereich basieren auf DIN 15018 Blatt 2 und Blatt 3 und F.E.M.

Die Tragfähigkeiten im Standsicherheitsbereich entsprechen DIN 15019 Teil 2 / ISO 4305.

Die zulässige Windgeschwindigkeit beträgt maximal 15 m/sec.

Die Tragfähigkeiten sind in metrischen Tonnen angegeben.

Das Gewicht des Lasthakens bzw. der Hakenflasche und weiterer Anschlagmittel ist von der Tragfähigkeit abzuziehen.

Die Tragfähigkeiten für den Teleskopausleger gelten nur bei demonstrierter Spitze.

Die Ausladung ist der horizontale Abstand von Mitte Drehkranz bis Mitte freihängender, nicht schwingender Last.

Tragfähigkeitsänderungen vorbehalten.

Obige Angaben dienen nur zur Information. Die Bedienungsanleitungen müssen zu Rate gezogen werden, bevor die Maschine in Betrieb genommen wird. Alle hier gemachten Angaben beziehen sich auf die Standard-Ausführung. Jegliche Ausrüstungsveränderungen können die angegebenen Werte beeinflussen.

Remarks relating to the rating charts

The lifting capacities in the structural area are based on DIN 15018 parts 2 and 3 and F.E.M.

The lifting capacities in the stability area are based on DIN 15019 part 2 / ISO 4305.

The maximum permissible wind speed for crane operation is 15 m/sec.

The lifting capacities shown are in metric tons.

The weight of load handling devices such as hook blocks, slings, etc., must be considered as part of the load and must be deducted from the lifting capacities.

The lifting capacities for the telescopic boom apply to a crane with no boom extensions being stowed or mounted on the crane.

The working radius is the horizontal distance from the centre of rotation to the centre of the freely suspended non-oscillating load.

The lifting capacities are subject to change without prior notice.

The above remarks are for basic information only and the operator's manual must be consulted before operating this crane. All data and performances refer to the standard crane. The addition of optional and other equipment may affect the performance of the crane.

Remarques relatives aux tableaux des charges

Les forces de levage sont conformes aux normes DIN 15018, p. 2 et 3, et F.E.M.

Les forces de levage dans la partie de stabilité au renversement sont conformes aux normes DIN 15019, chap. 2 / ISO 4305.

La grue peut travailler aux vitesses de vent allant jusqu'à 15 m/s.

Les forces de levage sont données en tonnes métriques.

Le poids du crochet-moufle et de tous les accessoires d'élingage font partie de la charge et sont à déduire des charges indiquées.

Les forces de levage indiquées pour la flèche télescopique s'entendent fléchette déposée.

Comme portée, on entend la distance horizontale du centre de la couronne de rotation au centre de la charge librement suspendue et non oscillante.

Sauf modification de forces de levage.

Les données ci-dessus servent à titre d'information. Avant la mise en marche de la grue il est conseillé d'étudier les instructions de service. Toutes les données indiquées ci-dessus se réfèrent à la machine de base. Tout changement de l'équipement de la grue peut influencer ces valeurs.

Notas relativas a los graficos de carga

En cuanto a los datos referentes a resistencia, las capacidades de carga están basados sobre las normas DIN 15018, pág. 2 y 3, y F.E.M.

En cuanto a los datos referentes a estabilidad anti-vuelco, las capacidades de carga están basados sobre las normas DIN 15019, Cap. 2 / ISO 4305.

La velocidad anemométrica max. admisible es de 15 m/seg.

Las capacidades de carga indicadas en las tablas corresponden a toneladas métricas.

Hay que deducir los pesos del gancho, eslingas y de otros dispositivos para fijación de cargas de los valores indicados en las tablas.

Las capacidades de carga referentes a la pluma telescópica valen solamente si el plumín está desmontada.

Como alcance se entiende la distancia horizontal desde el centro de la corona de giro hasta el centro de la carga suspendida libremente y no oscilante.

Salvo modificación de capacidades de carga, sin previo aviso.

Los datos arriba indicados sirven solamente para su información. Hay que leer las instrucciones para el uso antes de la puesta en servicio de la máquina. Todos los datos mencionados en las presentes tablas rigen para los modelos standard. Cualquier modificación del equipo montado puede dar lugar a modificaciones de aquellos valores.

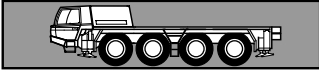

Rahmen Verwindungs- und biegesteife Schweißkonstruktion aus hochfestem Feinkornstahl.

Abstützung 4-Punkt-Abstützung, hydraulisch, Bedienungsmöglichkeiten an beiden Seiten des Fahrgestelles und in der Oberwagenkabine. Abstützbasis 7,2 m (und 5,0 m) x 8,59 m.

Motor Mercedes-Benz 6-Zylinder-Dieselmotor OM 501 LA (Euromot 2/EPA 2), wassergekühlt, Leistung 315 kW (428 PS) bei 1800 min⁻¹. Drehmoment 2000 Nm (204 kpm) bei 1080 min⁻¹.

Getriebe ZF-AS-Tronic 12AS 2302 mechanisches Schaltgetriebe mit 12 Vorwärts- und 2 Rückwärtsgängen.

Antrieb 8 x 6

Achsen

1. Achse: gelenkt, angetrieben, Differentialsperre quer.
2. Achse: gelenkt, nicht angetrieben.
3. Achse: gelenkt, angetrieben, Differentialsperre längs und quer.
4. Achse: gelenkt, angetrieben, Differentialsperre quer.

Achsaufhängung Hydropneumatische Federung mit Niveauregulierung.

Bremsen Druckluft-Zweikreis-Bremsanlage mit ABV System. Feststellbremse als Federspeicherbremse an der 2., 3. und 4. Achse wirkend. Dauerbremse als Konstantdrosselanlage mit Auspuffklappenbremse.

Räder 8-fach 16.00 R 25

Lenkung ZF-Halblock-Zweikreis-Hydraulenlenkung. Mechanische Lenkung der 1. und 2. Achse, hydraulisch unterstützt, Notlenkpumpe. Lenkung aller Achsen möglich. Hydrostatische Lenkung aller Achsen aus der Oberwagenkabine.

Unterswagenkabine Zwei-Mann-Frontfahrerhaus in Stahl-Kunststoff-Verbund-Konstruktion, Sicherheitsverglasung, luftgefederte Sitze und motorabhängige Warmwasserheizung, Kontroll- und Bedienungselemente für den Fahrbetrieb.

Elektrische Anlage 24 Volt-Gleichstrom, 2 Batterien. Die elektrische Anlage entspricht der EG-Norm.

Zusatzrüstung (gegen Mehrpreis) Anhängerkupplung, Zusatzheizung, Motorvorwärmung, Klimaanlage, 8 x 8 Antrieb, Wirbelstrombremse, 14.00 R 25 Bereifung, 20.5 R 25 Bereifung, Reserverad, Sonderlackierung und Beschriftung. Weitere Zusatzrüstung auf Anfrage.

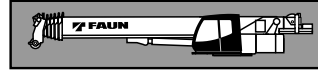

Rahmen Verwindungssteife Schweißkonstruktion mit einer außenverzahnten, einreihigen Kugeldrehverbindung, um 360° unbegrenzt drehbar.

Motor Mercedes-Benz 4-Zylinder-Dieselmotor OM 904 LA (Euromot 2/EPA 2), wassergekühlt. Leistung 125 kW (170 PS) bei 2300 min⁻¹. Drehmoment 660 Nm (67 kpm) bei 1200 min⁻¹ (Motorleistung nach DIN 6270B/DIN 6271).

Hydraulik System Diesel-hydraulisch mit 3-Kreis-Hydraulik, 1 leistungsgeregelte Axialkolbendoppelpumpe (elektrisch verstellbar und Cross-Sensing) und 1 Zahnrad-Doppelpumpe.

Steuerung Zwei 4-fach Kreuzsteuerhebel mit elektrischer Vorsteuerung.

Teleskopausleger Sechsteiliger, kastenförmiger Teleskopausleger, bestehend aus einem Grundausleger und 5 Teleskopteilen, hydraulisch unter Teillast teleskopierbar. 10,8 m - 48,5 m lang.

Wippwerk Ein Differentialzylinder mit angebaute Senkbremssperrentil.

Hubwerk Axialkolben-Konstant-Motor, Hubwerkstrommel mit eingebautem Planetengetriebe und federbelasteter Hydro-Lamellenbremse mit integriertem Freilauf beim Heben. Hubseil mit "Superstop"-Einrichtung.

Drehwerk Konstant-Motor, zweistufiges Planetengetriebe mit fußbetätigter Betriebsbremse und Feststellung. Drehgeschwindigkeit stufenlos von 0 - 2 min⁻¹.

Gegengewicht Gesamtgewicht 7 t teilbar. Die Bedienung erfolgt aus der Oberwagenkabine.

Oberwagenkabine Großräumige Krankabine in Stahl-Kunststoffausführung mit Sicherheitsverglasung mit getönten Scheiben, kippbarem Arbeitsplatz mit verstellbarem, gefederten, gedämpftem Fahrersitz, motorabhängige und motorunabhängige Warmwasserheizung (mit Motor-Vorwärmung), Kontroll- und Bedienungselemente für Kranbetrieb, Verfahrbarkeit vom Oberwagen und Abstützbetätigung.

Elektrische Anlage 24 Volt-Gleichstrom, 2 Batterien.

Sicherheitseinrichtungen Lastmomentbegrenzung (LMB), Hubendschalter, Windenendschalter, Seilwindendrehmelder, Sicherheitsventile gegen Rohr- und Schlauchbrüche. Sperrventile an Hydraulik-Zylindern.

Zusatzrüstung (gegen Mehrpreis) Auslegerverlängerung 9,0 m - 16,0 m lang, abwinkelbar (5°, 20° und 40°), Zusatzgegengewicht 11 t, 6 t Hakengeschild, 20 t, 40 t und 63 t Unterflasche, 2. Hubwerk (Seilzug 68 kN 1. Lage), Klimaanlage, Sonderlackierung und Beschriftung. Weitere Zusatzrüstung auf Anfrage.

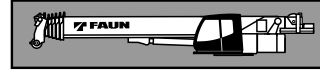
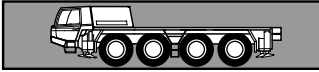

Frame Torsion resistant, welded construction made from high strength, fine-grained steel.

Outriggers 4 point hydraulic outriggers with controls on both sides of carrier and in superstructure cab. Outrigger base 7.2 m (and 5.0 m) x 8.59 m.

Carrier engine Mercedes-Benz 6 cylinder model OM 501 LA (Euromot 2/EPA 2), water-cooled diesel engine. Rated at 315 kW (428 HP) at 1800 rpm. Torque 2000 Nm (204 kpm) at 1080 rpm.

Transmission ZF-AS-Tronic model 12AS2302 with 12 forward and 2 reverse gears.

Drive 8 x 6

Axles

1st axle: steered, driven, with differential lock, transverse.

2nd axle: steered, not driven.

3rd axle: steered, driven, with differential locks longitudinal and transverse.

4th axle: steered, driven, with differential lock, transverse.

Suspension Hydro-pneumatic with levelling adjustment.

Brake system Service brakes: dual circuit compressed air system with ABS. Parking brake: spring loaded type acting on 2nd, 3rd and 4th axles. Auxiliary brakes: engine exhaust brake and constant throttle engine brake system.

Tyres (8) 16.00 R 25.

Steering system From carrier cab: ZF semi-block dual circuit hydraulic steering, mechanical steering of front two axles with hydraulic assistance, emergency steering pump. Steering of all axles possible. All axles steered hydrostatically from superstructure cab.

Carrier cab Two man full width cab of composite (steel sheet metal and fibre-glass) structure, with safety glass, air-cushioned adjustable seats, engine dependent hot-water heater. Complete controls and instrumentation for road travel.

Electrical system 24 volt DC system, 2 batteries, conforms with EEC regulations.

Optional Equipment (at extra charge) Towing attachment, additional heater, engine pre-heat, air conditioning, 8 x 8 drive, eddy current retarder brake, 14.00 R 25 tyres, 20.5 R 25 tyres, spare wheel and tyre, special painting and lettering. Further optional equipment available upon request.

Frame Torsion-resistant, all-welded structure of high strength steel. Connected to carrier by single-row ball-bearing slewing ring with external gearing for 360° continuous rotation.

Superstructure engine Mercedes-Benz 4 cylinder model OM 904 LA (Euromot 2/EPA 2), water cooled, diesel engine. Rated at 125 kW (170 HP) at 2300 rpm. Torque 660 Nm (67 kpm) at 1200 rpm (engine rating according to DIN 6270B/DIN 6271).

Hydraulic system Three circuit diesel hydraulic system with 1 powercontrolled axial piston double pump (electrically adjustable and with "Cross Sensing") and 1 double gear pump.

Controls Electric, 2 joy-stick levers for simultaneous operation of crane motions.

Telescopic boom 6 section box type construction of high tensile, fine-grained steel, consisting of 1 base section and 5 telescoping sections. All telescope sections extendable under partial load. 10.8 m to 48.5 m long.

Derricking system 1 double acting hydraulic cylinder with integral brake and holding valve.

Main winch Axial piston constant displacement motor, winch drum with integrated planetary reduction and with hydraulically controlled spring-loaded, multiple disc brake and with integrated free rotation (no sagging of load when hoisting). Hoist cable with "Superstop" easy reeving system.

Slewing system Constant displacement motor with two-stage planetary reduction with a foot actuated service and a parking brake. Speed infinitely variable 0 - 2 rpm.

Counterweight Standard 7 t divisible, assembled and disassembled by hydraulic cylinders controlled from superstructure cab.

Superstructure cab Spacious panoramic cab of composite (steel sheet metal and fibre-glass) structure, with safety (tinted) glass windows, adjustable, cushioned seat together with instrumentation panel and crane controls are reclining, one engine dependent hot-water heater and one engine independent hot-water heater (with engine pre-heat). Complete controls and instrumentation for crane operation, on-site travelling and outriggers.

Electrical system 24 volt DC system, 2 batteries.

Safety devices Load moment device (LMD), hoist limit switch, lower limit switch, drum turn indicator, safety valves against pipe and hose rupture, holding valves on hydraulic cylinders.

Optional Equipment (at extra charge) Telescopic boom extension 9.0 m -16.0 m long (offsets 5°, 20° and 40°), additional counterweight 11 t, 6 t headache ball, 20 t, 40 t and 63 t hook block, auxiliary winch (line pull 68 kN 1st layer), air conditioning. Special painting and lettering. Further optional equipment available upon request.

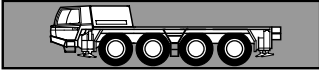

Châssis Construction mécano-soudée, en acier fin, résistante aux flexions et aux torsions.

Calage Calage à 4 points, complètement hydraulique. Commande des stabilisateurs latéralement à gauche et à droite du châssis et à partir de la cabine du grutier. Calage 7,2 m (aussi 5,0 m) x 8,59 m.

Moteur Mercedes Benz diesel de 6 cylindres, modèle OM 501 LA (Euromot 2/ EPA 2), refroidi par eau, de 315 kW (428 CV) à 1800 tr./min. Couple: 2000 Nm (204 kpm) à 1080 tr./min.

Boîte de vitesse Boîte mécanique ZF-AS-Tronic, modèle 12AS 2302, avec 12 vitesses AV et 2 vitesses AR.

Entraînement 8 x 6

Essieux

1^{er} essieu: directeur, entraîné, blocage de différentiel entre-roues

2^{ème} essieu: directeur, non entraîné

3^{ème} essieu: directeur, entraîné, blocage de différentiel longitudinal et entre-roues

4^{ème} essieu: directeur, entraîné, blocage de différentiel entre-roues

Suspension Hydro-pneumatique, avec réglage de niveau

Freins Système à air comprimé, à double circuit, avec système ABS. Frein de stationnement: avec accumulateurs à ressort agissant sur le 2^{ème}, 3^{ème} et 4^{ème} essieu. Frein continu: Frein sur échappement avec étrangleur

Pneus 8 x 16.00 R 25

Direction Semi-bloc à double circuit, marque ZF. Direction mécanique du 1^{er} et 2^{ème} essieu, à assistance hydraulique, avec pompe de direction auxiliaire. Direction de tous les essieux possible. Direction hydro-statique de tous les essieux depuis la cabine du grutier.

Cabine Cabine bi-place, construction en matière combinée acier / synthétique. Vitrage en verre de sécurité, sièges à suspension pneumatique. Chauffage à eau chaude relié au moteur. Organes de contrôle et de commande pour la conduite.

Système électrique 24 V courant continu, 2 batteries, conforme aux normes CE.

Équipement supplémentaire (contre supplément de prix) Attache-remorque, chauffage auxiliaire, préchauffage du moteur, climatisation, entraînement 8 x 8, frein électrique, pneus 14.00 R 25, pneus 20.5 R 25, roue de secours, peinture spéciale et inscription. Autres équipements supplémentaires sur demande.

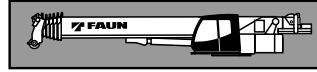

Plate forme Construction mécano-soudée résistante à la torsion. Couronne d'orientation à billes à une rangée, à denture extérieure, permettant une rotation illimitée sur 360°.

Moteur Mercedes Benz diesel de 4 cylindres, modèle OM 904 LA (Euromot 2/ EPA 2), refroidi par eau, de 125 kW (170 CV) à 2300 tr./min. Couple: 660 Nm (67 kpm) à 1200 tr./min. (Puissance selon DIN 6270B / DIN 6271).

Système hydraulique Diesel-hydraulique à 3 circuits, 1 double pompe à pistons axiaux à régulation de puissance (à réglage électrique et cross-sensing) et 1 pompe à engrenages.

Commande 2 manipulateurs à commande en croix (4 sens), assistés électriquement.

Flèche télescopique 1 flèche de base et 5 éléments télescopiques, hydrauliquement télescopables aussi sous charge partielle. Flèche en forme de caisson avec une logueur de 10,8 m à 48,5 m.

Mécanisme de relevage 1 vérin différentiel muni de clapet de freinage de descente.

Mécanisme de levage Moteur hydraulique, tambour de levage avec boîte planétaire incorporée, frein d'arrêt à disques multiples à ressort, libéré lors du levage. Câble de levage avec dispositif "Super-Stop".

Orientation Moteur hydraulique avec entraînement planétaire à 2 gammes. Frein de service actionné par l'intermédiaire d'une pédale et frein de stationnement. Vitesse de rotation 0 à 2 tr./min. en continu.

Contrepoids Poids total 7 t divisible, commandé depuis la cabine du grutier.

Cabine du grutier Cabine de grue spacieuse, construction en matière combinée acier / synthétique, avec vitrage de sécurité en verre teinté, siège réglable et amorti hydrauliquement, inclinable avec instruments de commande, chauffage à eau chaude dépendant et indépendant du moteur (avec préchauffage du moteur), éléments de commande et de contrôle pour travaux sur chantier, conduite et calage de la grue depuis la cabine du grutier.

Système électrique 24 V courant continu, 2 batteries.

Dispositifs de sécurité Limiteur de charge (CEC), interrupteur de fin de course de levage et de treuil, indicateur du nombre de tours, soupapes de sécurité contre ruptures des conduites et flexibles, clapets sur vérins hydrauliques.

Équipement supplémentaire (contre supplément de prix) Fléchette de 9,0 m à 16,0 m, inclinable à 5°, 20° et 40°), contre-poids additionnel de 11 t, crochet de 6 t, mouffles de 20 t, 40 t et 63 t, 2^{ème} treuil de levage (effort au brin simple 68 kN 1^{er} brin), climatisation, peinture spéciale et inscription. Autres équipements supplémentaires sur demande.

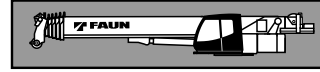
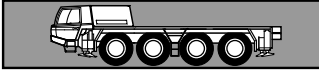

Chasis portante Construcción de acero de alta resistencia soldado, resistente a la torsión y a la flexión.

Estabilizadores Estabilizadores hidráulicos de 4 puntos. Posibilidad de manejo desde ambos lados del chasis portante y desde la cabina de la grúa. Extensión de los estabilizadores: 7,2 m (y 5,0 m) x 8,59 m.

Motor Mercedes Benz modelo OM 501 LA (Euromot 2/EPA 2), 6 cilindros, diesel, refrigerado por agua. Nominal 315 kW (428 HP) a 1800 rpm. Par 2000 Nm (204 kpm) a 1080 rpm.

Transmisión Transmisión mecánica ZF tipo AS-Tronic, modelo 12AS 2302, con 12 marchas adelante y 2 marchas atrás.

Tracción 8 x 6

Ejes

- 1º eje: de dirección, accionado, con bloqueo diferencial transversal
- 2º eje: de dirección, no accionado
- 3º eje: de dirección, accionado, con bloqueo diferencial longitudinal y transversal
- 4º eje: de dirección, accionado, con bloqueo diferencial transversal

Suspensión Suspensión hidroneumática con regulación de nivel.

Sistemas de frenos Accionamiento neumático de doble circuito con sistema anti bloqueo ABS. Freno de estacionamiento del tipo muelles cargados, liberados por aire, sobre los ejes 2º, 3º y 4º. Freno continuo: sistema estrangulador constante y freno tipo estrangulación sobre el escape del motor diesel.

Neumáticos 8 x 16.00 R 25

Dirección Hidráulica ZF semibloqueo de doble circuito. Giro mecánico sobre los ejes 1º y 2º, asistido hidráulicamente. Bomba hidráulica de emergencia accionada por la transmisión. Dirección de todos los ejes posible. Desde la cabina de la superestructura: dirección hidro-estática de ambos ejes.

Cabina Cabina para dos personas, en construcción de acero y fibra de vidrio. Cristales de seguridad, asiento con suspensión neumática, calefacción por agua caliente del motor. Elementos de control e instrumentos para circulación por carretera.

Sistema eléctrico Sistema de 24 V c.c. con 2 baterías, de acuerdo con las normas CE.

Equipo adicional (con suplemento de precio)
Embrague de remolque, calefacción adicional, precalefacción del motor, climatización, tracción 8 x 8, freno eléctrico, neumáticos 14.00 R 25, neumáticos 20.5 R 25, rueda de repuesto, pintura especial e inscripción. Otros equipos adicionales bajo demanda.

Superestructura Construida en aceros soldados, resistente a la torsión. Corona de giro con rodamiento de una fila de bolas con dientes externos para giro continuo de 360°.

Motor Mercedes Benz modelo OM 904 LA (Euromot 2/EPA 2), 4 cilindros, diesel, refrigerado por agua. Nominal 125 kW (170 HP) a 2300 rpm. Par 660 Nm (67 kpm) a 1200 rpm. (Potencia del motor según DIN 6270B/DIN 6271)

Sistema hidráulico Sistema hidráulico de 3 circuitos, 1 bomba doble de pistones axiales de caudal variable (regulable eléctricamente) y una bomba de engranajes.

Mandos 2 palancas de control de tipo joy-stick para movimientos simultáneos de la grúa (4 direcciones), asistidos eléctricamente.

Pluma telescópica 6 secciones del tipo cajón, un tramo base y 5 telescópicos. Los tramos se pueden telescopar hidráulicamente bajo carga. Longitud de 10.8 m a 48,5 m.

Elevación de pluma Mediante un cilindro hidráulico de doble efecto con válvula de retención integrada.

Cabrestante principal Motor hidráulico de pistones axiales y caudal fijo. Tambor del cabrestante con reducción planetaria y freno de discos múltiples con muelles cargados. Cable de elevación con sistema de enhebrado fácil y "Super-Stop".

Sistema de giro Motor hidráulico con reducción planetaria de dos etapas. Freno de servicio controlado por pedal y freno de estacionamiento. Velocidad de giro variable de 0 a 2 rpm.

Contrapeso Peso total de 7 t divisible, accionado desde la cabina de la grúa.

Cabina de la grúa Cabina espaciosa, en construcción de acero y fibra de vidrio, con cristales coloreados de seguridad. Asiento del operador regulable amortiguado hidráulicamente, inclinable junto con los instrumentos y mandos, calefacción por agua caliente dependiente e independiente del motor (con precalefacción del motor). Controles, instrumentos y mandos de conducción para la operación de la grúa y para el desplazamiento en obra. Mandos para nivelación y extensión de los estabilizadores.

Sistema eléctrico Sistema de 24 V c.c. con 2 baterías.

Dispositivos de seguridad Dispositivo de momento de carga, interruptor de límite de elevación y de carrera del cabrestante. Indicador de vueltas del tambor. Válvulas de seguridad contra rotura de tuberías y latiguillos, válvulas de retención en los cilindros hidráulicos.

Equipo adicional (con suplemento de precio)
Plumín de 9,0 m a 16,0 m, acodable en 5°, 20° y 40°, contrapeso suplementario de 11 t, gancho de bola de 6 t, ganchos de 20 t, 40 t y 63 t, segundo cabrestante (tiro por ramal de 68 kN capa 1), climatización, pintura especial e inscripción. Otros equipos adicionales bajo demanda.

Hakenhöhen / Kopfhöhen
 Hook height / Tip height
 Hauteurs sous crochet / Hauteurs tête de flèche
 Altura del gancho / Altura de la punta

