



GR-800EX



GR-600EX



GR-300EX

Photos include optional equipment.



GR-800EX GR-600EX

80 METRIC TON CAPACITY

60 METRIC TON CAPACITY

GR-300EX

30 METRIC TON CAPACITY

ROUGH TERRAIN CRANE



*The GR-EX Models:
High Quality We Are Proud Of*

The photo includes optional equipment.

Plenty of new functions incorporated!

HELLO-NET system	03
The Environmentally Friendly Features	04
Fuel Monitoring System	05
Eco Mode System	
Positive Control System	

Crane

The Ultimate boom for the rough terrain crane	07
Assist cylinder for jib	08
Jib installation	
Two telescoping modes I & II	
New crane structure	
Bi-fold jib	09
Two winches with cable follower	10
Automatic moment limiter [AML-C]	11
Outrigger asymmetric extension width control	12
Operator comfort	13
Seat adjustment	14
Adjustment of control lever stand	
Wider steps and hand rails	

Carrier

New carrier frame	15
Winch drum monitoring mirror	
High performance engine	
Dashboard indicator and warning symbols	16
Smooth transmission	
Fastest travel speed	17
Comfortable suspension	
Axle	
Brake systems	
4 steering modes	

WORKING RANGE & DIMENSION

19

SPECIFICATIONS

21

**GR-300EX**

Crane capacity: 30,000 kg at 3.0 m
4-section long boom: 9.7 m - 31.0 m
2-staged jib: 7.2 m / 12.8 m

GR-600EX

Crane capacity: 60,000 kg at 3.0 m
5-section long boom: 11.0 m - 43.0 m
2-staged bi-fold jib: 10.1 m / 17.7 m

GR-800EX

Crane capacity: 80,000 kg at 3.0 m
5-section long boom: 12.0 m - 47.0 m
2-staged bi-fold jib: 10.1 m / 17.7 m

New Generation of Cranes

Our cranes can help you explore your future. At Tadano we are concerned about our environment. Improving our cranes operations and specifications to meet this goal is important to us. However user friendliness, operator comfort, safety and customer support are also part of our essential goals. To this end Tadano has launched a new generation of crane that is friendly to the environment, our earth and our future.

NEW FEATURES

HELLO-NET System

Tadano supports your crane management via the Internet, providing information about operational status, position and maintenance.



HELLO-NET Owner's Site enables sharing of machine data between Tadano Group and machine owners. We offer you advanced customer support.



Monitoring machine information from your computer

1. Work History

HELLO-NET Owner's Site displays the day-to-day operational status, mileage and remaining fuel for each machine equipped with a communication terminal. In addition, you can view a list displaying the number of hours of operation and the mileage of all your machines for any specified month.

2. Machine Position Data

Using HELLO-NET Owner's Site, you can check a machine's latest position (up until the previous day) on a map. Two types of position data, listed below, are transmitted automatically from your machine once every day. Work Site: The location where the machine's PTO has been activated (for one hour or more). Position at Day's End: The final location from which GPS was able to receive data on a given day.



3. Maintenance Information

You can check the maintenance timetable of your machines for periodical replacement parts and inspection schedule. HELLO-NET supports the maintenance of your machine.

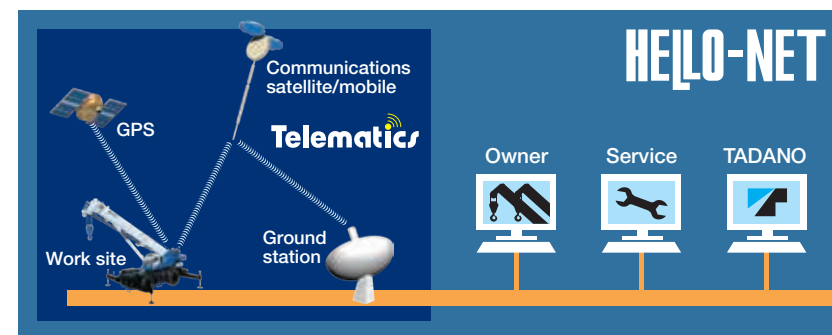
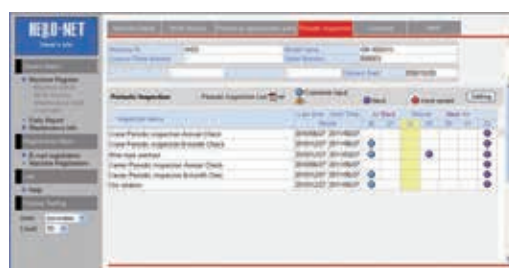

Telematics (machine data logging and monitoring system) with HELLO-NET via internet (*availability depends on the situation).
 DETAILS: The availability of data communication systems, such as satellite or mobile communications which serve to widen the service area differs according to individual countries. Besides, there are some countries where the system itself is not in use yet. For details, please contact your distributor or our sales staff in charge.

The Environmentally Friendly Features

Designed to minimize environmental impact.



Tadano's rough terrain cranes are equipped with Fuel Monitoring System, Eco Mode System and Positive Control Systems that substantially reduce fuel consumption and CO₂ emissions.

Introducing Fuel Monitoring System

The Fuel Monitoring System, displayed on the AML-C screen, monitors fuel consumption rates during crane operations, idling, and while traveling, allowing the operator to optimize fuel efficiency, reduce CO₂ emissions and noise level.



Two devices reduce fuel consumption

Tadano aims to reduce fuel consumption by its two newly developed technologies, the Eco Mode System and the Positive Control System. Consideration was given to the length of actual operating hours as well as non-operating time (when the crane is in a state of idling). In this relation, the average ratio between the operating hours and the non-operating time is 40/60% according to the results of our investigation. This understanding helped us to successfully achieve our objectives.

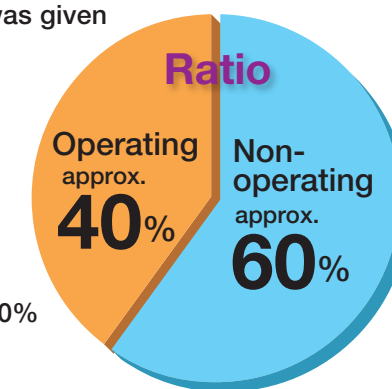

Eco Mode System - reduces fuel consumption by approximately 40% while the crane is being operated.

Positive Control System - reduces fuel consumption by approximately 60% when the crane is in a state of idling.

Fuel Monitoring System

The Fuel Monitoring System constantly monitors fuel consumption on the AML screen. Checking this monitor enables you to prevent wasteful fuel consumption from unnecessary acceleration and idling.

Working

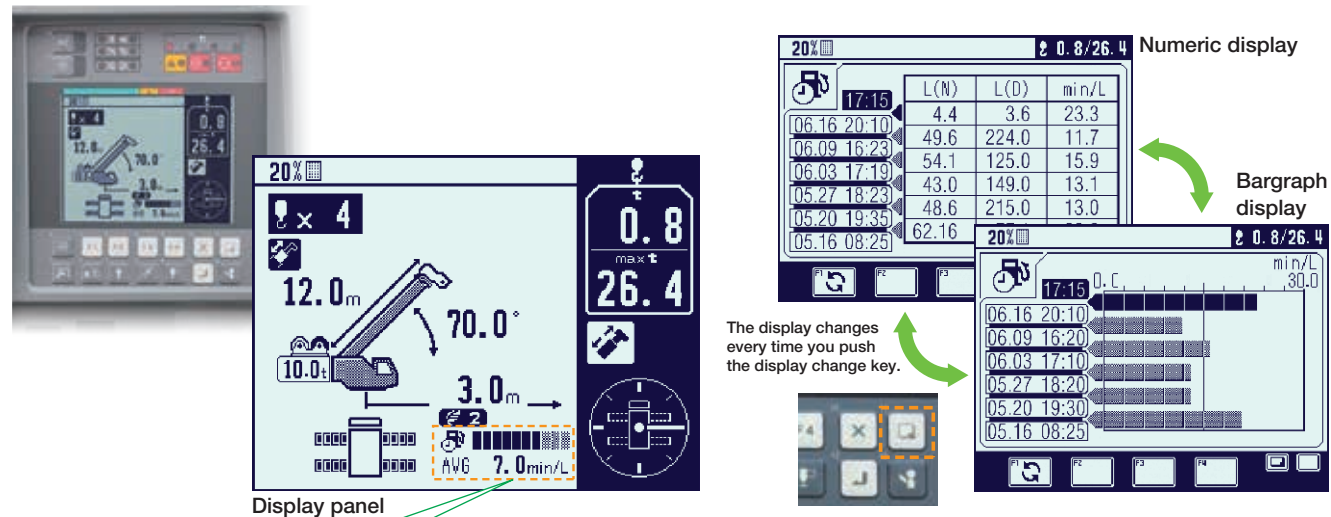

Driving

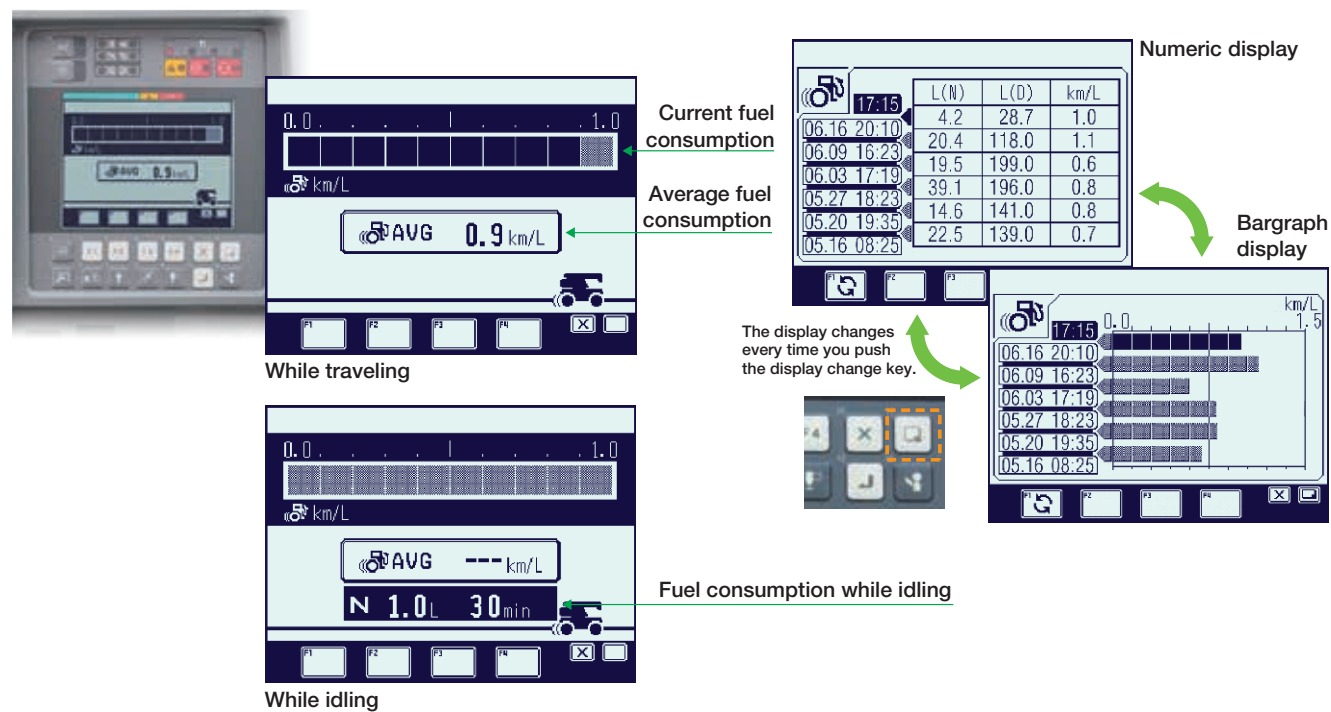

Eco Mode System

The Eco Mode System controls the maximum engine speed at the time of crane operation. To prevent an unnecessary rise in engine speed when there is excessive acceleration, the system enables fuel consumption and CO₂ emissions to decrease by Max. 22% with Eco mode 1, and Max. 30% with Eco mode 2, and the noise level is reduced.

Fuel consumption CO₂ emissions

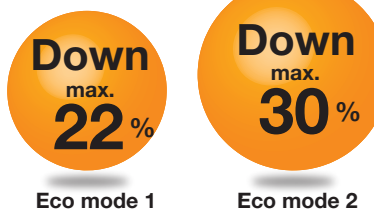

Screen setting the Eco mode to be selected

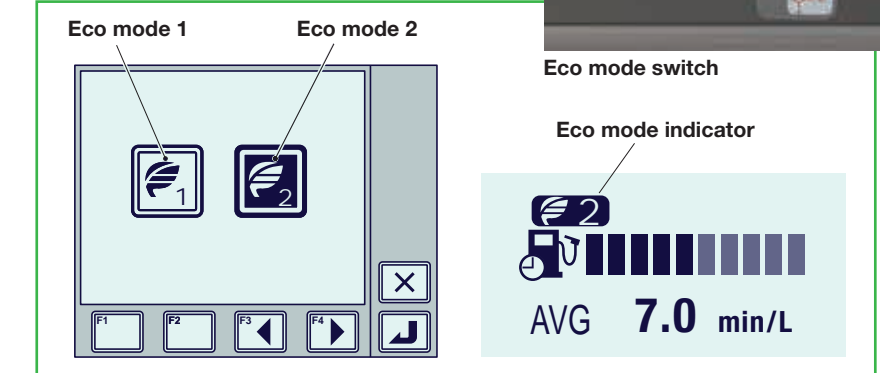

Positive Control System

The Positive Control System effectively controls the quantity of hydraulic pump discharge during crane operation in response to the amount of movement applied by the operating control lever. When the crane is in a state of idling, the Positive Control System keeps the quantity of hydraulic pump discharge to a minimum, reducing fuel consumption and CO₂ emissions by up to 20%.

Fuel consumption and CO₂ emissions ratio compared with the conventional system

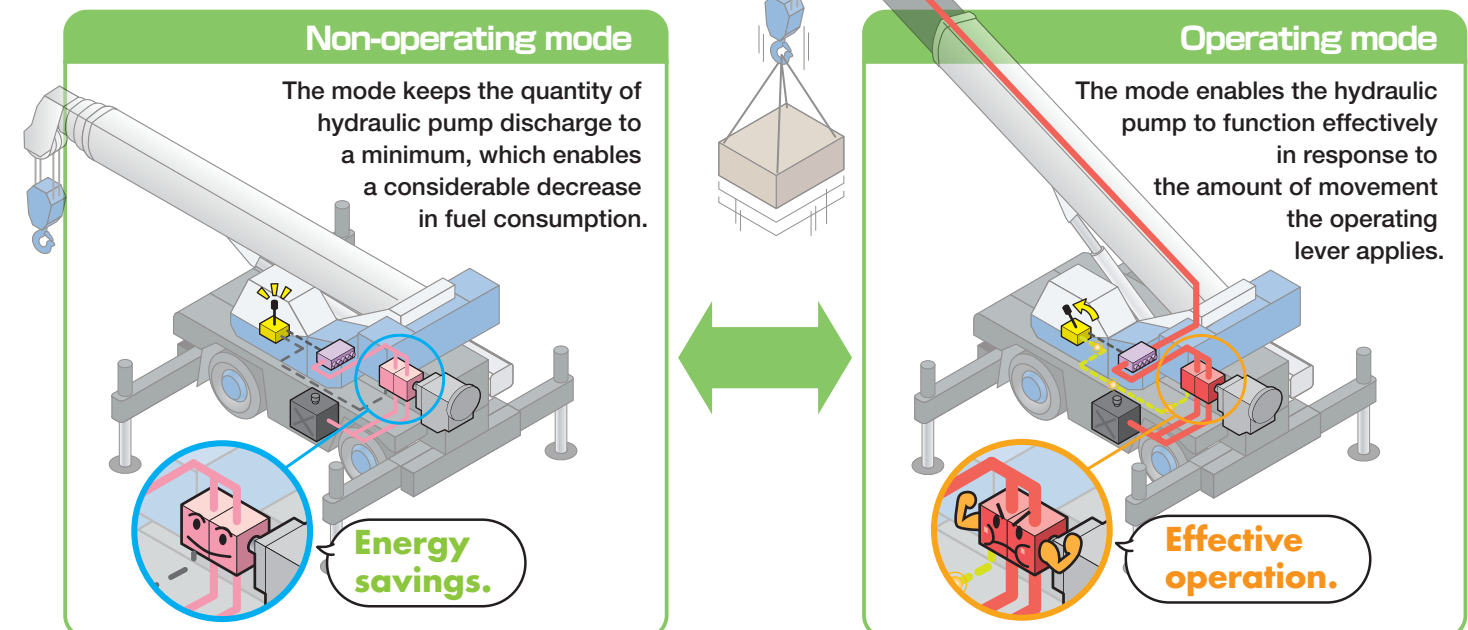



Crane



New Design

The Ultimate boom for the rough terrain crane (GR-800EX, GR-600EX)

The rounded boom is made of high tensile steel, which allows for decreased boom weight and increased boom strength. The high performance AML-C comes standard and aids the operator in maintaining a safe operation.



GR-300EX

The round hexagonal box boom (GR-300EX)

Assist cylinder for jib (optional)

(GR-800EX, GR-600EX)

When mounting and stowing the jib, the assist hydraulic cylinders are used resulting in increased work efficiency and safety.

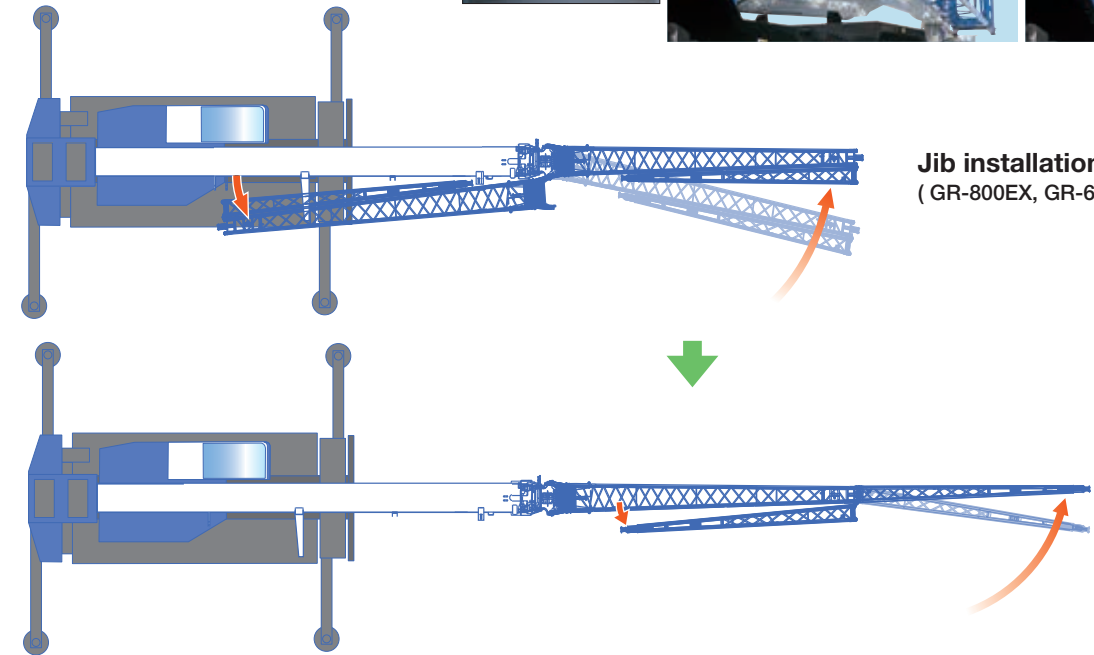

Jib installation (GR-800EX, GR-600EX)

Two telescoping modes I & II

(GR-800EX, GR-600EX)

The operator has enhanced capabilities with two boom telescoping options whichever suits the lift needs.



Mode I

Mode I is extension of 2nd section only. Then follows the synchronized extension of 3rd, 4th and 5th sections.



Mode II

Mode II is synchronized extension of 3rd, 4th and 5th sections. Then 2nd section extends independently.

New crane structure (GR-800EX, GR-600EX)

During development of the structural shape of the crane, *FEM analysis was applied to achieve a design tailored for optimal operation. The slewing frames' structure ensures a highly rigid, compact style that is well suited for the overall planned design of the crane. Continuing the Tadano tradition of excellence and innovation.

*FEM: Finite Element Method

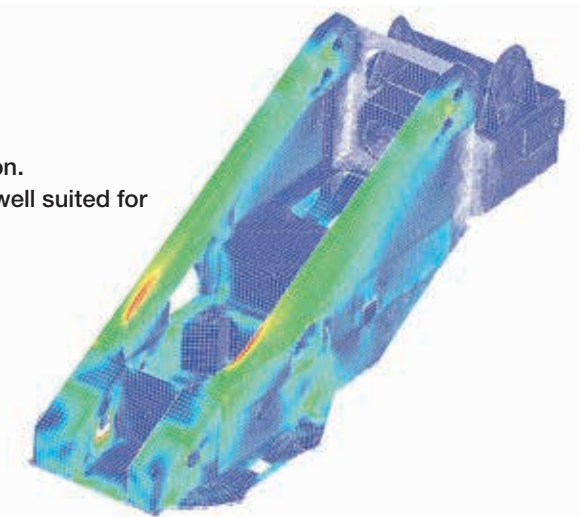

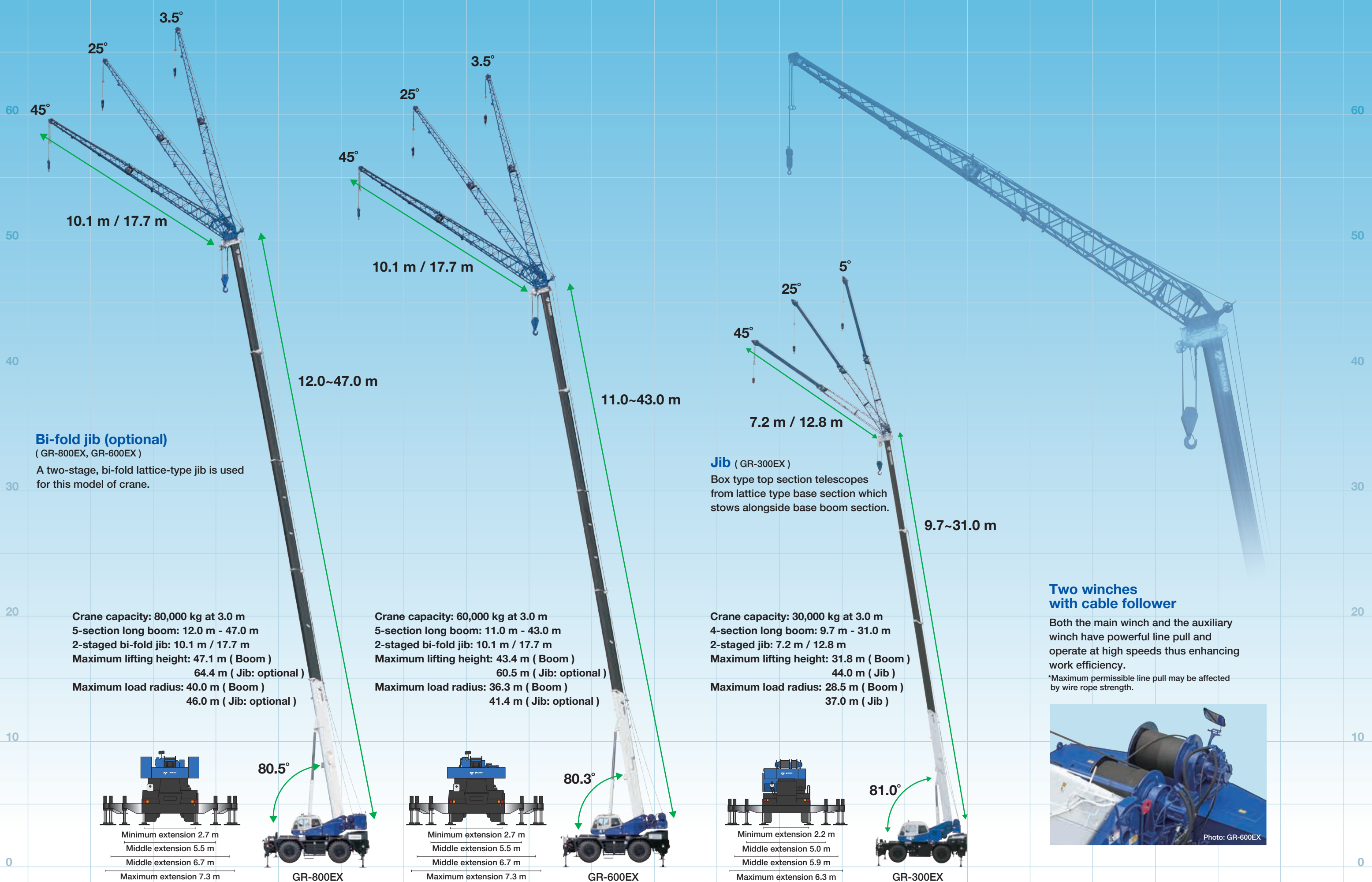

Bi-fold jib (optional)

(GR-800EX, GR-600EX)

A two-stage, bi-fold lattice-type jib is used for this model of crane.

Jib (GR-300EX)

Box type top section telescopes from lattice type base section which stows alongside base boom section.

Two winches with cable follower

Both the main winch and the auxiliary winch have powerful line pull and operate at high speeds thus enhancing work efficiency.

*Maximum permissible line pull may be affected by wire rope strength.

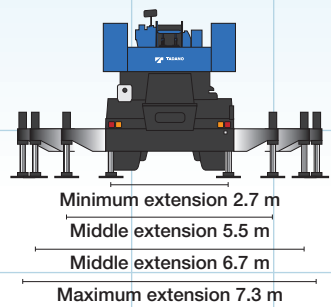

Photo: GR-600EX

Crane capacity: 80,000 kg at 3.0 m
 5-section long boom: 12.0 m - 47.0 m
 2-staged bi-fold jib: 10.1 m / 17.7 m
 Maximum lifting height: 47.1 m (Boom)
 64.4 m (Jib: optional)
 Maximum load radius: 40.0 m (Boom)
 46.0 m (Jib: optional)

Crane capacity: 60,000 kg at 3.0 m
 5-section long boom: 11.0 m - 43.0 m
 2-staged bi-fold jib: 10.1 m / 17.7 m
 Maximum lifting height: 43.4 m (Boom)
 60.5 m (Jib: optional)
 Maximum load radius: 36.3 m (Boom)
 41.4 m (Jib: optional)

Crane capacity: 30,000 kg at 3.0 m
 4-section long boom: 9.7 m - 31.0 m
 2-staged jib: 7.2 m / 12.8 m
 Maximum lifting height: 31.8 m (Boom)
 44.0 m (Jib)
 Maximum load radius: 28.5 m (Boom)
 37.0 m (Jib)



GR-800EX

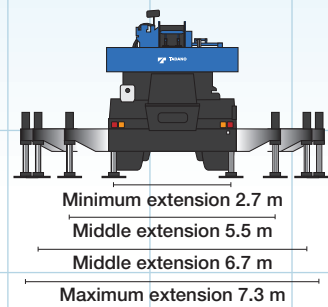

GR-600EX

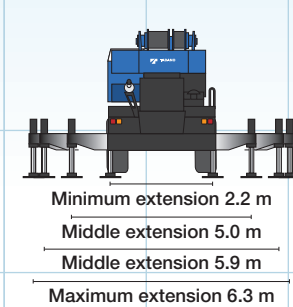

GR-300EX

Automatic moment limiter [AML-C]

Tadano's AML-C is easy to use, innovative in design, displays important information to the operator and enables the operator to preset a custom working environment. For example, the AML-C shows the boom angle, boom length, load radius, operating pressure of the elevating cylinder, the extension width of the outriggers, slewing position, rated lifting capacity and present hook load. These features allow the AML-C to move seamlessly through all lifting operations without having to change configurations or input new codes to make the lift.

The AML-C safety features provide both audible and visual warnings. When an operation approaches the load limit Tadano's slow stop function engages to avoid shock loads.



Drum rotation indicator

To let the operator know when the winch is rotating, the drum rotation indicator on the AML beeps and flashes sequentially. The moving distance of the hook block per one flash of the indicator is approximately 7.9 in. to 11.8 in. (20 cm to 30 cm).

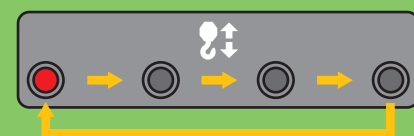

AML display symbols

Labels for AML display symbols include: Moment load ratio, Jib length, Jib lift, Number of part lines, Boom telescoping mode, Boom length, Boom lift, Winch selection, Outrigger status, Eco mode, Fuel consumption, Load radius, Boom angle, Jib offset angle, Hook load, Rated lifting capacity, Control selector switch, Slewing position, Front position, and AML lamp.

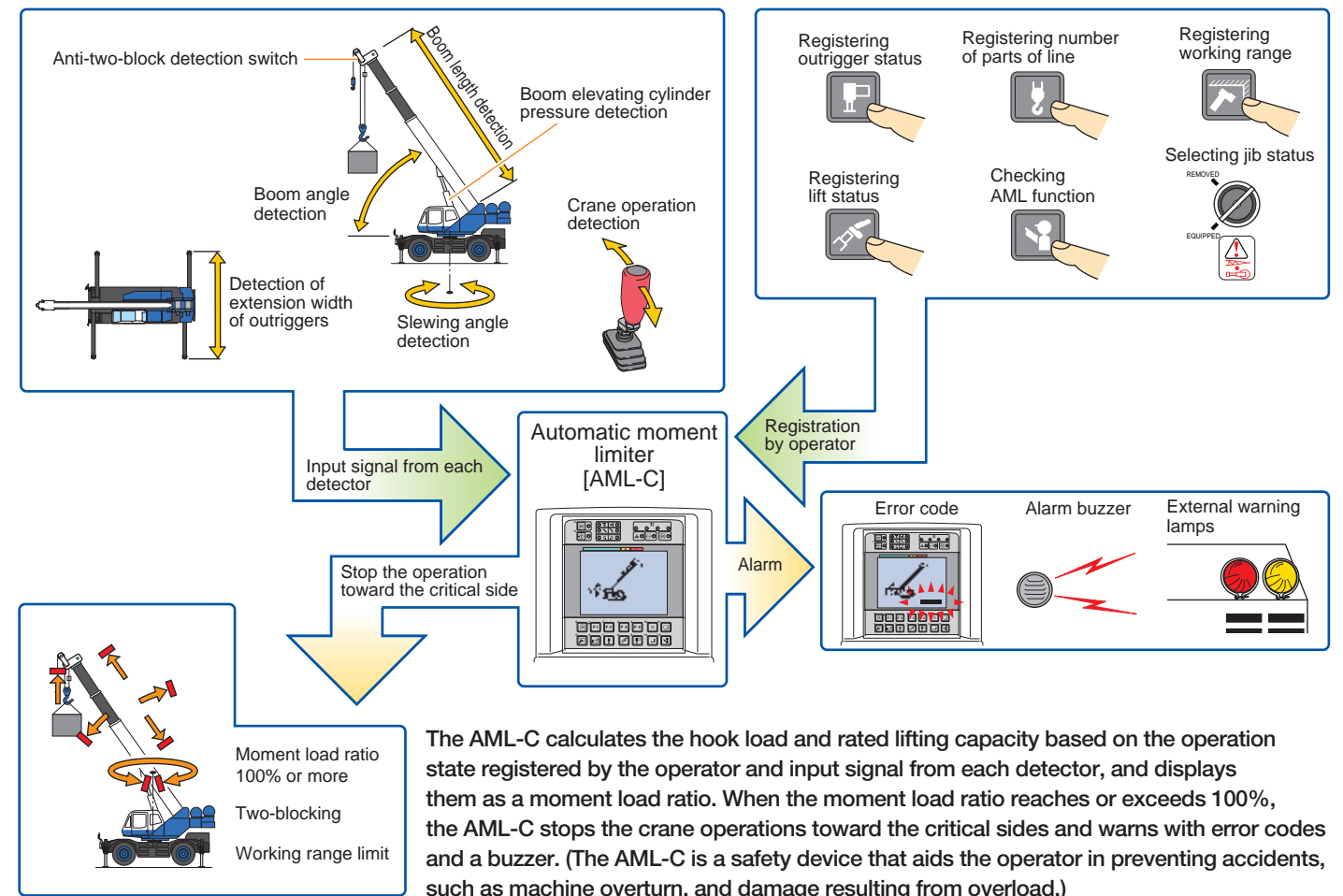

The AML-C calculates the hook load and rated lifting capacity based on the operation state registered by the operator and input signal from each detector, and displays them as a moment load ratio. When the moment load ratio reaches or exceeds 100%, the AML-C stops the crane operations toward the critical sides and warns with error codes and a buzzer. (The AML-C is a safety device that aids the operator in preventing accidents, such as machine overturn, and damage resulting from overload.)

Safety First!

Outrigger asymmetric extension width control

When operating the crane with the asymmetric outriggers extended, the AML-C detects the extension width of all of the Crane's outriggers (front, rear, left and right) to measure maximum work capacity in each area. When slewing the boom from the longer outrigger area to the shorter outrigger area, the AML-C detects the motion and displays the maximum capacity according to the extension width of each of the outriggers, and brings the motion to a slow stop before it reaches the maximum capacity. Therefore, even in the case of operator error, the AML-C's slow stop function will help to minimize any safety risk.

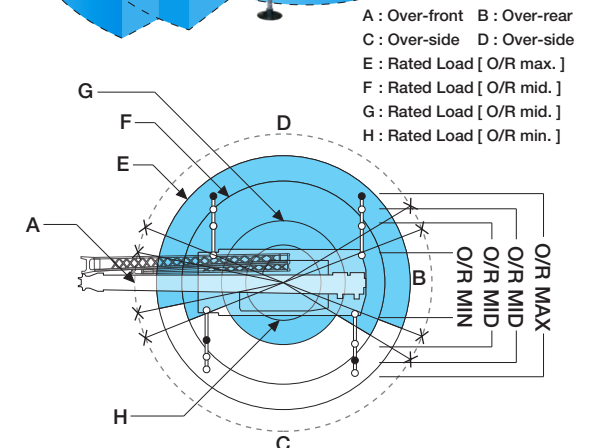
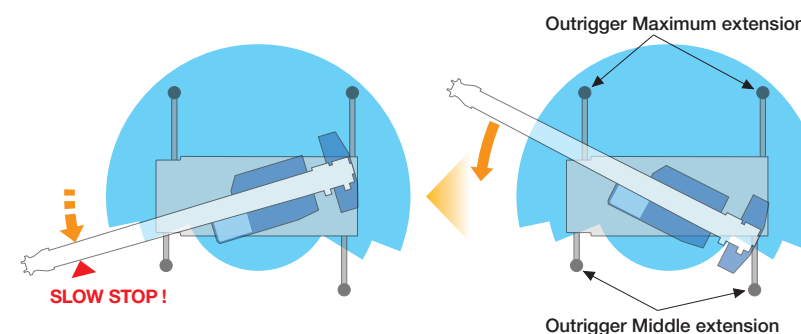
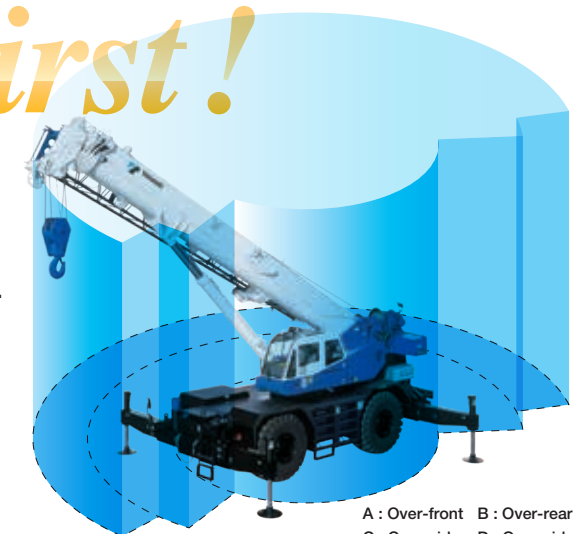

Operator comfort

The crane cab provides improved livability and a more comfortable working environment.



Photo: GR-600EX



Air conditioner
Hot-water heater and air conditioning.

The control levers are smooth and responsive to the operators touch.



Wider steps and hand rails



Photo: GR-800EX, GR-600EX

Front steps

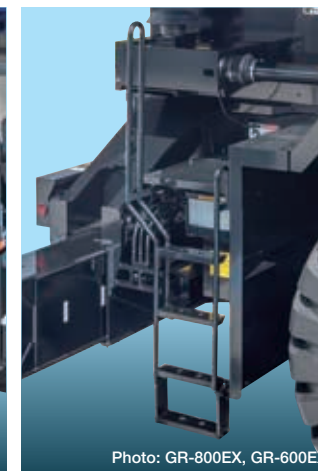

Photo: GR-800EX, GR-600EX

Rear steps



Photo: GR-800EX, GR-600EX

Left side steps

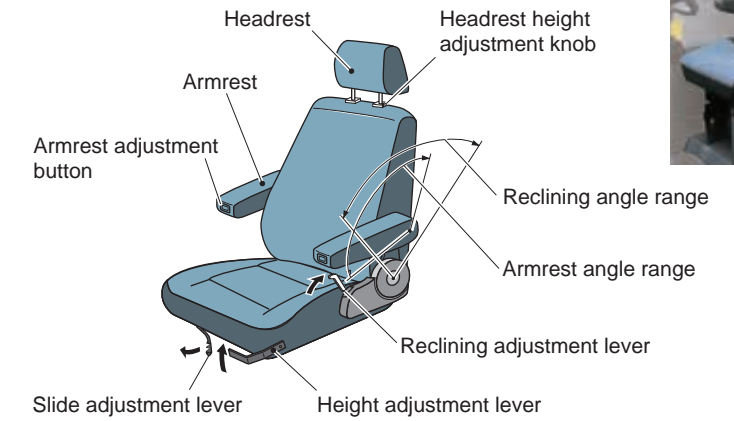

Photo: GR-800EX, GR-600EX

Right side steps

Seat adjustment

Multiple seat adjustment positions for ease of operation.



Adjustment of control lever stand

- The control lever stand has a 3-stage adjustment feature.
- Before you enter or exit the cab, or when you complete the crane operation, set the control lever stand on the left to the stowing position.
- The unlock lever is used by pulling to adjust for all positions of the control lever stand.

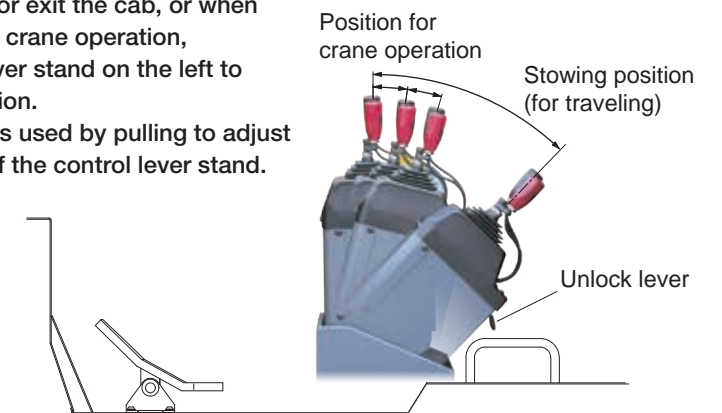



Photo: GR-800EX

Carrier



New carrier frame (GR-800EX, GR-600EX)

The new carrier frame design was developed and built so that its lightweight is compatible with its high rigidity to achieve an advanced level of performance. As a result, the rigidity was enhanced by as much as *35% which enables highly stabilized maneuverability for the new model of crane.

*Compared with our conventional crane models

Winch drum monitoring mirror (GR-800EX, GR-600EX)

Folding mirror reduces height during transport.

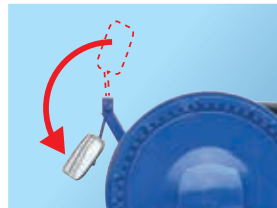

High performance engine

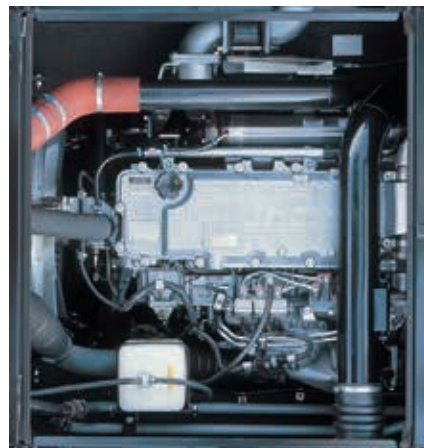

Mitsubishi 6M60-TLU3R [ECE-R96-02]

GR-800EX, GR-600EX

Model	Mitsubishi 6M60-TLU3R [ECE-R96-02]
Type	4-cycle, turbo charged and after cooled, 6-cylinder, direct injection diesel.
Piston displacement	7.54 liters
Max. output	200 kW at 2,600 min ⁻¹ {rpm}
Max. torque	785 N·m at 1,400 min ⁻¹ {rpm}



Cummins QSB6.7 EU stage IIIA

GR-300EX

Model	Cummins QSB6.7 EU stage IIIA
Type	4-cycle, turbo charged and after cooled, 6-cylinder, direct injection diesel.
Piston displacement	6.70 liters
Max. output	160 kW at 2,500 min ⁻¹ {rpm}
Max. torque	843 N·m at 1,600 min ⁻¹ {rpm}



Photo: GR-600EX

Dashboard indicator and warning symbols

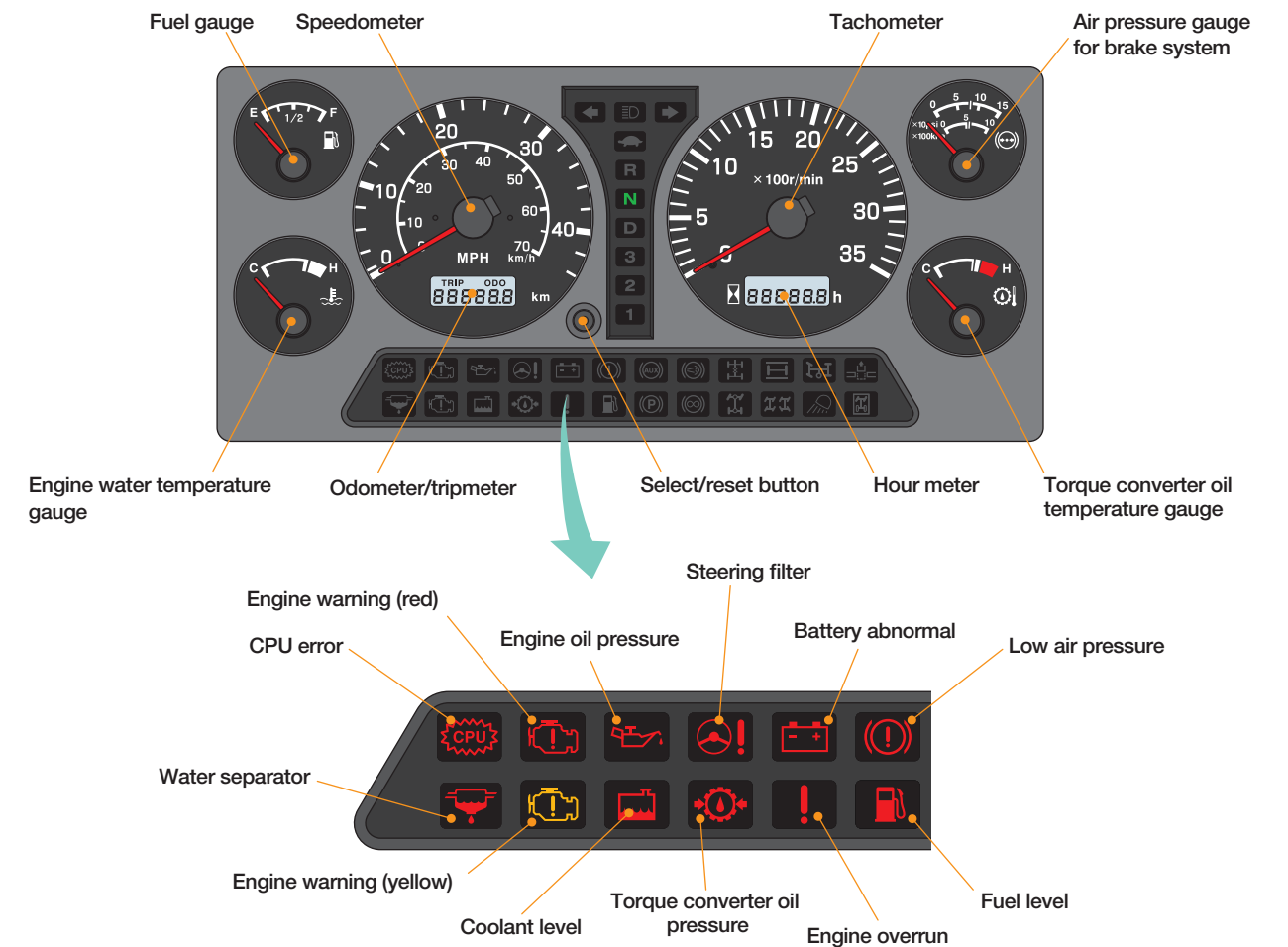

Smooth transmission

- Electronically controlled, fully automatic transmission.
- Torque converter driving full power shift with driving axle selector.
- 6 forward and 2 reverse speeds, constant mesh.

GR-800EX, GR-600EX

3 speeds - High range - 2 wheel drive; 4 wheel drive
3 speeds - Low range - 4 wheel drive

GR-300EX

4 speeds - High range - 2 wheel drive; 4 wheel drive
4 speeds - Low range - 4 wheel drive

Fastest traveling speed (GR-300EX)

Maximum traveling speed 50 km/h
Cummins Engine + 6 forward speeds transmission

Comfortable suspension (GR-300EX)

Semi-elliptic leaf springs with hydraulic lockout device provide good riding comfort.



Axle

Front: Full floating type, steering and driving axle with planetary reduction.

Rear: Full floating type, steering and driving axle with planetary reduction and non-spin rear differential.

Brake Systems

Service: Air over hydraulic disc brakes on all 4 wheels.

Parking/Emergency: Spring applied-air released brake acting on input shaft of front axle.

Auxiliary: Electropneumatic operated exhaust brake.

4 steering modes

Hydraulic power steering.



GR-800EX GR-600EX GR-300EX

			GR-800EX	GR-600EX	GR-300EX
Traveling on roads		2 wheel front Front steering only. This steering method is the same as that of general vehicles.	<input type="radio"/>	<input type="radio"/>	<input type="radio"/>
Driving in work site		2 wheel rear Rear steering only. The rear end of the vehicle swings outward like a forklift. Useful for easy approach of a narrow area.	<input type="radio"/>	<input type="radio"/>	<input type="checkbox"/>
Driving in work site		4 wheel coordinated Front and rear wheels are steered in opposite directions. The turning radius is decreased. Useful for movement in a small area.	<input type="radio"/>	<input type="radio"/>	<input type="radio"/>
		4 wheel crab Front and rear wheels are steered in the same direction. The vehicle can move diagonally. Useful for pulling over.	<input type="radio"/>	<input type="radio"/>	<input type="radio"/>

GR-800EX

Max. traveling speed: 36 km/h
Overall length: approx. 14,375 mm
Overall width: approx. 3,315 mm
Overall height: approx. 3,795 mm
Min. turning radius (at center of extreme outer tire)
2-wheel steering: 11.9 m
4-wheel steering: 6.8 m



GR-600EX

Max. traveling speed: 36 km/h
Overall length: approx. 13,380 mm
Overall width: approx. 3,315 mm
Overall height: approx. 3,790 mm
Min. turning radius (at center of extreme outer tire)
2-wheel steering: 11.9 m
4-wheel steering: 6.8 m



GR-300EX

Max. traveling speed: 50 km/h
Overall length: approx. 11,245 mm
Overall width: approx. 2,620 mm
Overall height: approx. 3,535 mm
Min. turning radius (at center of extreme outer tire)
2-wheel steering: 9.8 m
4-wheel steering: 5.8 m



MODEL	GR-800EX	GR-600EX
MAXIMUM CAPACITY	80,000 kg at 3.0 m	60,000 kg at 3.0 m
PERFORMANCE		
Max. Traveling speed	36 km/h	36 km/h
Gradeability (tan θ)	94% (at stall), 30%* * Machine should be operated within limit of engine crackcase design. (17": Mitsubishi 6M60-TL)	147% (at stall), 30%* * Machine should be operated within limit of engine crackcase design. (17": Mitsubishi 6M60-TL)
WEIGHT		
Gross vehicle mass	52,110 kg (incl. 80 ton hook block)	44,275 kg (incl. 60 ton hook block)
front axle	25,675 kg	22,515 kg
rear axle	26,435 kg	21,760 kg
MIN. TURNING RADIUS	11.9 m (2-wheel steering), 6.8 m (4-wheel steering) (at center of extreme outer tire)	11.9 m (2-wheel steering), 6.8 m (4-wheel steering) (at center of extreme outer tire)
BOOM		
Fully retracted length	5-section full power telescoping boom. 12.0 m	5-section full power telescoping boom. 11.0 m
Fully extended length	47.0 m	43.0 m
Extension speed	35.0 m in 160 s	32.0 m in 128 s
Angle	-1.5°-80.5°	-1.6°-80.3°
Elevation speed	20° to 60° in 46 s	20° to 60° in 46 s
JIB (optional)		
	2-staged bi-fold lattice type with triple offset (tilt type). Single sheave at jib head.	2-staged bi-fold lattice type with triple offset (tilt type). Single sheave at jib head.
Offset	3.5°, 25°, 45°	3.5°, 25°, 45°
Length	10.1 m and 17.7 m	10.1 m and 17.7 m
MAIN WINCH		
	Variable speed type with grooved drum driven by hydraulic axial piston motor.	Variable speed type with grooved drum driven by hydraulic axial piston motor.
Single line pull	64.7 kN (6,600 kgf)	54.9 kN (5,600 kgf)
Single line speed	149 m/min. (at 4th layer)	128 m/min. (at 4th layer)
Wire rope	19 mm x 253 m (Diameter x length)	19 mm x 235 m (Diameter x length)
AUXILIARY WINCH		
	Variable speed type with grooved drum driven by hydraulic axial piston motor.	Variable speed type with grooved drum driven by hydraulic axial piston motor.
Single line pull	64.7 kN (6,600 kgf)	54.9 kN (5,600 kgf)
Single line speed	128 m/min. (at 2nd layer)	110 m/min. (at 2nd layer)
Wire rope	19 mm x 139 m (Diameter x length)	19 mm x 133 m (Diameter x length)
SLEWING		
Slewing speed	1.5 min ⁻¹ {rpm}	2.4 min ⁻¹ {rpm}
Tail slewing radius	4,190 mm	4,190 mm
HYDRAULIC SYSTEM		
	Pumps... 2 variable piston pumps for crane functions. Tandem gear pump for steering, slewing and optional equipment. Control valves... Multiple valves actuated by pilot pressure with integral pressure relief valves. Reservoir... 763 liters capacity. External sight level gauge. Oil cooler... Air cooled fan type.	Pumps... 2 variable piston pumps for crane functions. Tandem gear pump for steering, slewing and optional equipment. Control valves... Multiple valves actuated by pilot pressure with integral pressure relief valves. Reservoir... 763 liters capacity. External sight level gauge. Oil cooler... Air cooled fan type.
TADANO Automatic Moment Limiter (Model: AML-C)	Following information is displayed: • Control lever lockout function with audible and visual pre-warning • Number of parts of line • Boom position indicator • Outrigger state indicator • Slewing angle • Boom angle / boom length / jib offset angle / jib length / load radius / rated lifting capacities / actual loads read out • Potential lifting height • Ratio of actual load moment to rated load moment indication • Permissible load • Automatic speed reduction and slow stop function for boom elevation and slewing • Working condition register switch • Load radius / boom angle / tip height / slewing range preset function • External warning lamp • Tare function • Main hydraulic oil pressure • Fuel consumption monitor • Main winch / auxiliary winch select • Drum rotation indicator (audible and visible type) main and auxiliary winch • On-rubber indicator	Following information is displayed: • Control lever lockout function with audible and visual pre-warning • Number of parts of line • Boom position indicator • Outrigger state indicator • Slewing angle • Boom angle / boom length / jib offset angle / jib length / load radius / rated lifting capacities / actual loads read out • Potential lifting height • Ratio of actual load moment to rated load moment indication • Permissible load • Automatic speed reduction and slow stop function for boom elevation and slewing • Working condition register switch • Load radius / boom angle / tip height / slewing range preset function • External warning lamp • Tare function • Main hydraulic oil pressure • Fuel consumption monitor • Main winch / auxiliary winch select • Drum rotation indicator (audible and visible type) main and auxiliary winch • On-rubber indicator
OUTRIGGERS		
	4 hydraulic, beam and jack outriggers. Vertical jack cylinders equipped with integral holding valve. Each outrigger beam and jack is controlled independently from cab. Max. ... 7,300 mm, Mid. ... 6,700 mm & 5,500 mm Min. ... 2,700 mm, Float size (Diameter) ... 600 mm	4 hydraulic, beam and jack outriggers. Vertical jack cylinders equipped with integral holding valve. Each outrigger beam and jack is controlled independently from cab. Max. ... 7,300 mm, Mid. ... 6,700 mm & 5,500 mm Min. ... 2,700 mm, Float size (Diameter) ... 600 mm
CARRIER		
	Rear engine, left-hand drive, driving axle 2-way selected type by manual switch. 4 x 2 front drive, 4 x 4 front and rear drive	Rear engine, left-hand drive, driving axle 2-way selected type by manual switch. 4 x 2 front drive, 4 x 4 front and rear drive
ENGINE		
Model.....	Mitsubishi 6M60-TLU3R [ECE-R96-02]	Mitsubishi 6M60-TLU3R [ECE-R96-02]
Type.....	4-cycle, turbo charged and after cooled, 6-cylinder, direct injection diesel.	4-cycle, turbo charged and after cooled, 6-cylinder, direct injection diesel.
Piston displacement...	7.54 liters	7.54 liters
Bore x stroke...	118 mm x 115 mm	118 mm x 115 mm
Max. output...	200 kW at 2,600 min ⁻¹ {rpm}	200 kW at 2,600 min ⁻¹ {rpm}
Max. torque...	785 N·m at 1,400 min ⁻¹ {rpm}	785 N·m at 1,400 min ⁻¹ {rpm}
TRANSMISSION		
	Electronically controlled full automatic transmission.	Electronically controlled full automatic transmission.
STEERING		
	Hydraulic power steering. 4 steering modes available: 2-wheel front, 2-wheel rear, 4-wheel coordinated, 4-wheel crab	Hydraulic power steering. 4 steering modes available: 2-wheel front, 2-wheel rear, 4-wheel coordinated, 4-wheel crab
SUSPENSION		
	Front..... Rigid mounted to frame. Rear..... Pivot mounted with hydraulic lockout cylinders.	Front..... Rigid mounted to frame. Rear..... Pivot mounted with hydraulic lockout cylinders.
TIRES		
	29.5-25 34PR (OR), Single x 4	29.5-25 22PR (OR) or 29.5-25 28PR (OR), Single x 4
FUEL TANK CAPACITY		
	300 liters	300 liters

MODEL	GR-300EX
MAXIMUM CAPACITY	30,000 kg at 3.0 m
PERFORMANCE	
Max. Traveling speed	50 km/h
Gradeability (tan θ)	78% (at stall), 57%* * Machine should be operated within limit of engine crackcase design. (30": Cummins QSB6.7**)
WEIGHT	
Gross vehicle mass	27,190 kg (incl. 30 ton hook block)
front axle	13,650 kg
rear axle	13,540 kg
MIN. TURNING RADIUS	9.8 m (2-wheel steering), 5.8 m (4-wheel steering) (at center of extreme outer tire)
BOOM	
Fully retracted length	4-section full power telescoping boom. 9.7 m
Fully extended length	31.0 m
Extension speed	21.3 m in 91 s
Angle	0°-81°
Elevation speed	20° to 60° in 22 s
JIB	
	2-staged jib with triple offset (tilt type). Single sheave at jib head.
Offset	5°, 25°, 45°
Length	7.2 m and 12.8 m
MAIN WINCH	
	Variable speed type with grooved drum driven by hydraulic axial piston motor.
Single line pull	39.2 kN (4,000 kgf)
Single line speed	125 m/min. (at 4th layer)
Wire rope	16 mm x 170 m (Diameter x length)
AUXILIARY WINCH	
	Variable speed type with grooved drum driven by hydraulic axial piston motor.
Single line pull	39.2 kN (4,000 kgf)
Single line speed	125 m/min. (at 4th layer)
Wire rope	16 mm x 98 m (Diameter x length)
SLEWING	
Slewing speed	3.2 min ⁻¹ {rpm}
Tail slewing radius	3,330 mm
HYDRAULIC SYSTEM	
	Pumps... 2 variable piston pumps for crane functions. Tandem gear pump for steering, slewing and optional equipment. Control valves... Multiple valves actuated by pilot pressure with integral pressure relief valves. Reservoir... 380 liters capacity. External sight level gauge Oil cooler... Air cooled fan type.
TADANO Automatic Moment Limiter (Model: AML-C)	Following information is displayed: • Control lever lockout function with audible and visual pre-warning • Number of parts of line • Boom position indicator • Outrigger state indicator • Slewing angle • Boom angle / boom length / jib offset angle / jib length / load radius / rated lifting capacities / actual loads read out • Potential lifting height • Ratio of actual load moment to rated load moment indication • Permissible load • Automatic speed reduction and slow stop function for boom elevation and slewing • Working condition register switch • Load radius / boom angle / tip height / slewing range preset function • External warning lamp • Tare function • Main hydraulic oil pressure • Fuel consumption monitor • Main winch / auxiliary winch select • Drum rotation indicator (audible and visible type) main and auxiliary winch • On-rubber indicator
OUTRIGGERS	
	4 hydraulic, beam and jack outriggers. Vertical jack cylinders equipped with integral holding valve. Each outrigger beam and jack is controlled independently from cab. Max. ... 6,300 mm, Mid. ... 5,900 mm & 5,000 mm Min. ... 2,200 mm, Float size (Diameter)... 400 mm
CARRIER	
	Rear engine, left-hand drive, driving axle 2-way selected type by manual switch. 4 x 2 front drive, 4 x 4 front and rear drive.
ENGINE	
Model.....	Cummins QSB6.7 EU stage IIIA
Type.....	4-cycle, turbo charged and after cooled, 6-cylinder, direct injection diesel.
Piston displacement...	6.70 liters
Bore x stroke...	107 mm x 124 mm
Max. output...	160 kW at 2,500 min ⁻¹ {rpm}
Max. torque...	843 N·m at 1,600 min ⁻¹ {rpm}
TRANSMISSION	
	Electronically controlled full automatic transmission.
STEERING	
	Hydraulic power steering. 3 steering modes available: 2-wheel front, 4-wheel coordinated, 4-wheel crab
SUSPENSION	
	Semi-elliptic leaf springs with hydraulic lockout device.
TIRES	
	445/95 R 25 (OR), Single x 4
FUEL TANK CAPACITY	
	300 liters



*Some specifications are subject to change